

JVC



ENGLISH

DEUTSCH

FRANÇAIS

NETHERLANDS

CD RECEIVER
CD-RECEIVER
RECEPTEUR CD
CD-RECEIVER

KD-SH77R/KD-SH55R

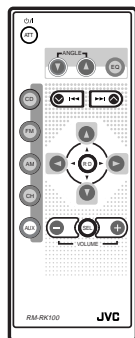
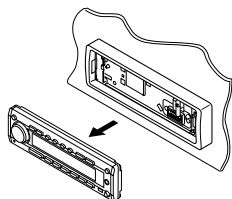

KD-SH77R

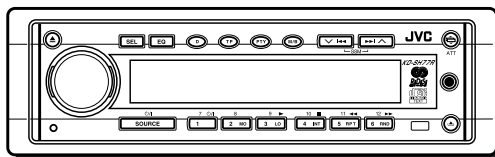

KD-SH55R

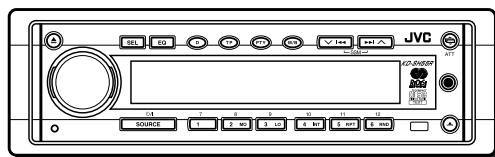

For installation and connections, refer to the separate manual.

Angaben zu Einbau und Verkabelung entnehmen Sie bitte der gesonderten Anleitung.

Pour l'installation et les raccordements, se référer au manuel séparé.

Zie de afzonderlijke handleiding voor details aangaande het installeren en verbinden van het toestel.

INSTRUCTIONS

BEDIENUNGSANLEITUNG
MANUEL D'INSTRUCTIONS
GEBRUIKSAANWIJZING

LVT0625-001A
[E/EX]

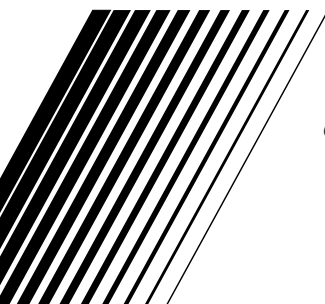

Position And Reproduction Of Labels

Bottom panel of the main unit

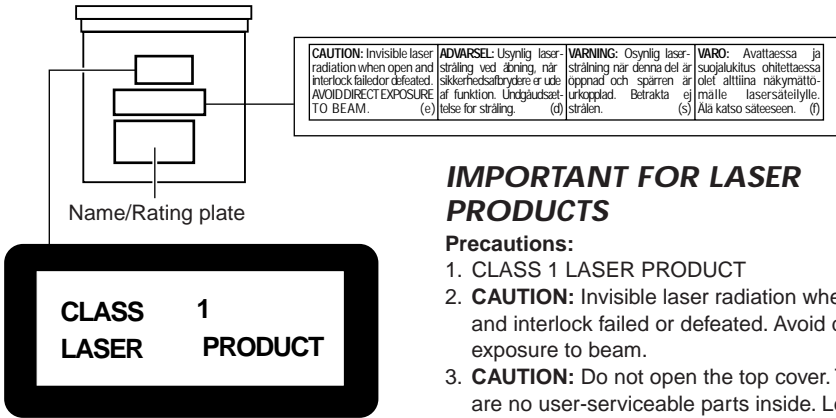

Caution:
This product contains a laser component of higher laser class than Class 1.

IMPORTANT FOR LASER PRODUCTS

Precautions:

1. CLASS 1 LASER PRODUCT
2. **CAUTION:** Invisible laser radiation when open and interlock failed or defeated. Avoid direct exposure to beam.
3. **CAUTION:** Do not open the top cover. There are no user-serviceable parts inside. Leave all servicing to qualified service personnel.
4. **CAUTION:** This CD player uses invisible laser radiation and is equipped with safety switches to prevent radiation emission when unloading CDs. It is dangerous to defeat the safety switches.
5. **CAUTION:** Use of controls, adjustments or performance of procedures other than those specified herein may result in hazardous radiation exposure.

How to reset your unit

Press the reset button on the front panel using a ball-point pen or similar tool.

Note:

Your preset adjustments – such as preset channels or sound adjustments – will also be erased.

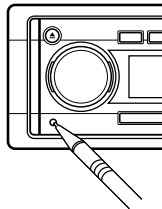

CAUTION:

NEVER insert your finger between the control panel and the unit, as it may get caught and hurt. (See page 28.)

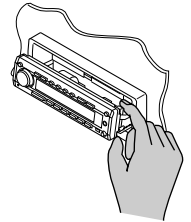

Note:

For security reasons, a numbered ID card is provided with this unit, and the same ID number is imprinted on the unit's chassis. Keep the card in a safe place, as it will help the authorities to identify your unit if stolen.

BEFORE USE

*For safety...

- Do not raise the volume level too much, as this will block outside sounds, making driving dangerous.
- Stop the car before performing any complicated operations.

*Temperature inside the car...

If you have parked the car for a long time in hot or cold weather, wait until the temperature in the car becomes normal before operating the unit.

Thank you for purchasing a JVC product. Please read all instructions carefully before operation, to ensure your complete understanding and to obtain the best possible performance from the unit.

CONTENTS

How to reset your unit	2	OTHER MAIN FUNCTIONS	23
LOCATION OF THE BUTTONS	4	Setting the clock	23
Control panel	4	Changing the general settings (PSM)	23
Remote controller	5	Assigning names to the sources	27
Preparing the remote controller	6	Changing the control panel angle	28
BASIC OPERATIONS	7	Detaching the control panel	29
RADIO BASIC OPERATIONS	8	EXTERNAL COMPONENT OPERATIONS ..	30
Listening to the radio	8	Playing external components	30
Storing stations in memory	9	CD CHANGER OPERATIONS	32
Tuning into a preset station	10	Playing CDs	32
RDS OPERATIONS	11	Selecting CD playback modes	33
What you can do with RDS EON	11	DAB TUNER OPERATIONS	34
Other convenient RDS functions and adjustments	14	Tuning into an ensemble and one of the services	34
CD OPERATIONS	17	Storing DAB services in memory	36
Playing a CD	17	Tuning into a preset DAB service	37
Playing a CD text	18	What you can do more with DAB	37
Locating a track or particular portion on a CD	18	ADDITIONAL INFORMATION	38
Selecting CD playback modes	19	MAINTENANCE	39
Prohibiting CD ejection	19	Handling CDs	39
SOUND ADJUSTMENTS	20	TROUBLESHOOTING	40
Adjusting the sound	20	SPECIFICATIONS	41
Selecting preset sound modes	21		
Storing your own sound adjustments	22		

About the demonstration mode (DEMO MODE)...

While shipped from the factory, "DEMO MODE" is set to "DEMO ON" in this unit.

The following demonstration, introducing the main features equipped for this unit, will appear on the display automatically if no sound comes in for 3 minutes. (See page 26.)

- **24bit DAC** : (24 bit digital-analog converter: Gives you a high quality sound after D/A conversion.)
- **HS TUNER** : (High-Sensitivity Tuner: Enables a fine reception of stations.)
- **EQUALIZER** : (Allows you to fine-adjust the sound to match your preference.)
- **SUB WOOFER** : (ONLY for KD-SH77R: Enables you to connect a subwoofer and to adjust its output level.)

CAUTION on Volume Setting

CDs produce very little noise compared with other sources. If the volume level is adjusted for the tuner, for example, the speakers may be damaged by the sudden increase in the output level. Therefore, lower the volume before playing a disc and adjust it as required during playback.



LOCATION OF THE BUTTONS

ENGLISH

Control panel

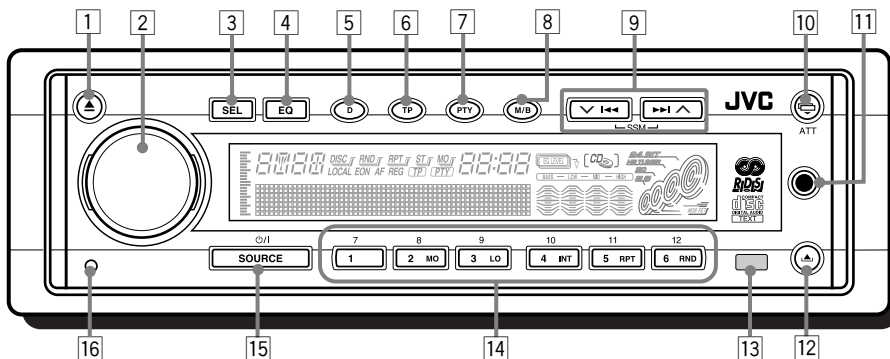

- | | |
|--|--|
| <ul style="list-style-type: none"> 1 ▲ (eject) button 2 Control dial 3 SEL (select) button 4 EQ (equalization) button 5 D (display) button 6 TP (traffic programme) button 7 PTY (programme type) button 8 M/B (mode/band) button 9 ►► / ▲ / ▼ / ◀◀ buttons <ul style="list-style-type: none"> • Also functions as SSM buttons when pressed together. 10 ⏻ ATT (angle / attenuator) button | <ul style="list-style-type: none"> 11 Auxiliary input jack 12 ⏻ (control panel release) button 13 Remote sensor 14 Number buttons <ul style="list-style-type: none"> • MO (monaural) button • LO (local) button • INT (intro scan) button • RPT (repeat) button • RND (random) button • Video component operation buttons (ONLY for KD-SH77R) 15 SOURCE ⏻/I (standby / on) button 16 Reset button |
|--|--|

How to use the number buttons:

If you press M/B (mode/band), the unit goes into functions mode and the number buttons work as different function buttons.

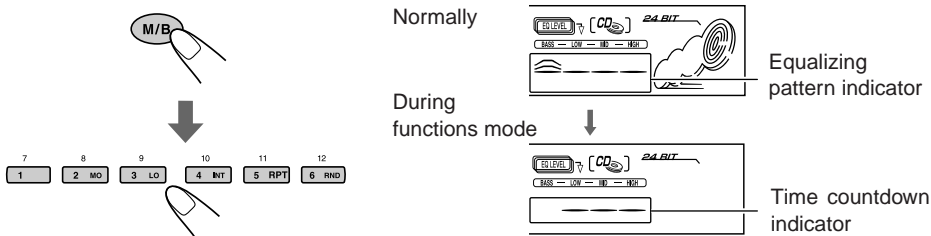

To use these buttons as number buttons again after pressing M/B (mode/band), wait for 5 seconds without pressing any number button until the functions mode is cleared.

- Pressing M/B (mode/band) again also clears the functions mode.



Remote controller

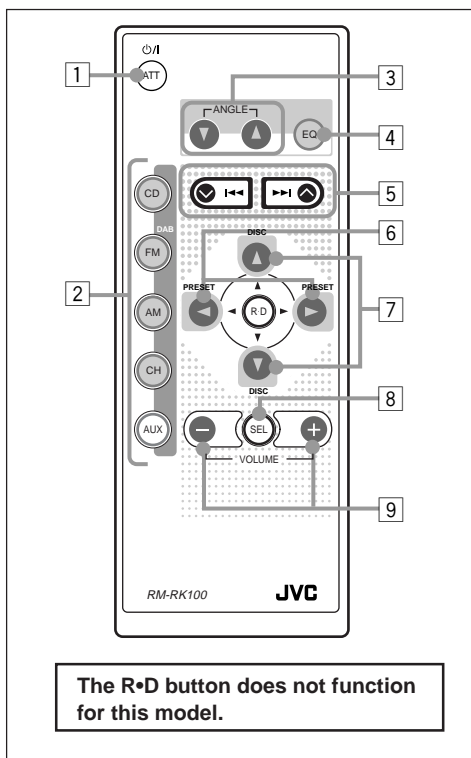

- 1 • Turns on the unit if pressed when the unit is turned off.
- Turns off the unit if pressed and held until “SEE YOU” appears on the display.
- Drops the volume level if pressed briefly, and “ATT” flashes on the display. Press again to resume the volume.
- 2 • CD : Selects CD player.
- FM : • Selects FM tuner if select briefly. Each time you press the button, FM band (FM1, FM2 and FM3) changes.
- Selects DAB tuner if pressed and held.* Each time you press and hold the button, DAB band (DAB 1, DAB 2 and DAB 3) changes.
- AM : Selects AM tuner.
- CH : Selects CD changer.*
- AUX : Selects the external components. Each time you press the button, “AUX INPUT” and “LINE INPUT”*** are alternately selected.

- 3 Changes the angle of the control panel in three positions.
- 4 Selects the sound modes. Each time you press the button, sound modes change.
- 5 • Searches stations while listening to the radio.
- Selects ensembles while listening to the DAB tuner if pressed briefly.
- Selects services while listening to the DAB tuner if pressed and held.
- Fast-forwards or reverses the track if pressed and held while listening to a CD.
- Skips to the beginning of the next track or goes back to the beginning of the current (or previous tracks) if pressed briefly while listening to a CD.
- 6 Changes the preset channel number while listening to the radio (or the DAB tuner). Each time you press the button, the preset channel number changes, and the selected station (or service) is tuned into.
- 7 Changes the disc number while listening to the CD changer. Each time you press the button, the disc number changes, and the selected disc starts playing.
- 8*** Selects the sound adjustment items. Each time you press the button, the items change.
- 9*** • Changes the volume.
- Adjusts the sound mode (after SEL is pressed).

* Without connecting the DAB tuner or CD changer, you cannot select it as the source to play.

** ONLY for KD-SH55R: To select the external component, you have to change the external component setting (see page 26).

*** These buttons do not function for the preferred setting mode adjustment.



Preparing the remote controller

Before using the remote controller:

- Aim the remote controller directly at the remote sensor on the main unit. Make sure there is no obstacle in between.

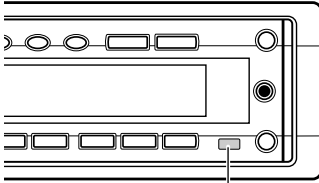

Remote sensor

- Do not expose the remote sensor to strong light (direct sunlight or artificial lighting).

Installing the battery

When the controllable range or effectiveness of the remote controller decreases, replace the battery.

1. Remove the battery holder.

- 1) Push out the battery holder in the direction indicated by the arrow using a ball-point pen or a similar tool.
- 2) Remove the battery holder.

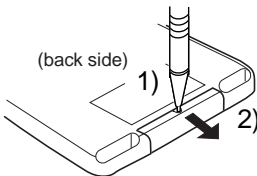

2. Place the battery.

Slide the battery into the holder with the + side facing upwards so that the battery is fixed in the holder.

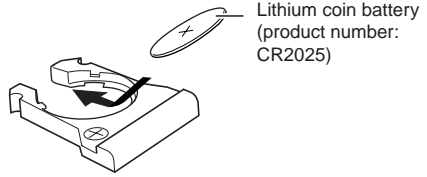

3. Return the battery holder.

Insert again the battery holder pushing it until you hear a clicking sound.

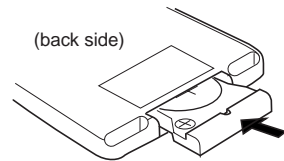

WARNING:

- Store the battery in a place where children cannot reach.
If a child accidentally swallows the battery, consult a doctor immediately.
- Do not recharge, short, disassemble or heat the battery or dispose it in a fire.
Doing any of these things may cause the battery to give off heat, crack or start a fire.
- Do not leave the battery with other metallic materials.
Doing this may cause the battery to give off heat, crack or start a fire.
- When throwing away or saving the battery, wrap it in tape and insulate; otherwise, the battery may start to give off heat, crack or start a fire.
- Do not poke the battery with tweezers or similar tools.
Doing this may cause the battery to give off heat, crack or start a fire.

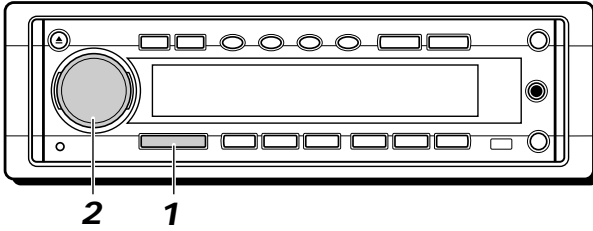

Note:
When you use this unit for the first time, set the built-in clock correctly, see page 23.

1 Turn on the power and select the source.

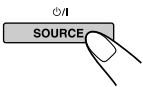

When you press the button for the first time, the power comes on. Then each time you press the button, the source changes as follows.

For KD-SH77R

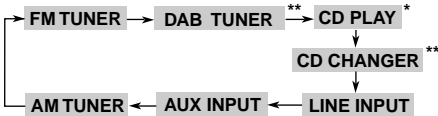

For KD-SH55R

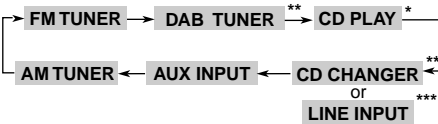

- * If a CD is not in the loading slot, you cannot select CD as the source to play.
- ** Without connecting the DAB Tuner or the CD changer; you cannot select it as the source to play.
- *** ONLY for KD-SH55R: To select the external component, you have to change the external component setting (see page 26).

- To operate the tuner (FM or AM), see pages 8 – 10.
- To operate the CD player, see pages 17 – 19.
- To operate external components (AUX INPUT and LINE INPUT), see pages 30 – 31.
- To operate the CD changer, see pages 32 – 33.
- To operate the DAB tuner, see pages 34 – 37.

2 Adjust the volume.

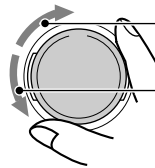

To increase the volume.

To decrease the volume.

Volume level appears.

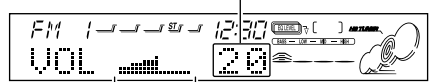

Volume level indicator

Note:

After adjusting the volume, you can push in the control dial to avoid unintended operations. To use it again, push the control dial again to make it come out.

3 Adjust the sound as you want. (See page 20.)

To drop the volume in a moment

Press and hold /ATT while listening to any source. "ATT" starts flashing on the display, and the volume level will drop in a moment.

To resume the previous volume level, press and hold the button again.

- If you turn the control dial clockwise, you can also restore the sound.

To turn off the power

Press and hold SOURCE until "SEE YOU" appears on the display.

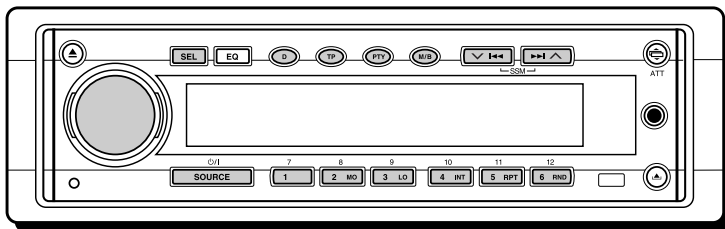

Listening to the radio

You can use either automatic searching or manual searching to tune into a particular station.

Searching a station automatically: Auto search

1 Select the FM or AM.

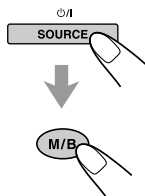

1 Press SOURCE repeatedly to select FM or AM as the source.

2 If necessary, to select the FM band number, press and hold M/B (mode/band) for more than 1 second repeatedly. Each time you press and hold the button, the FM band changes as follows:

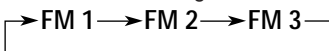

Selected band appears.

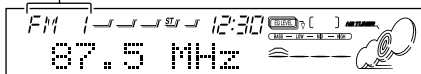

Note:

This receiver has three FM bands (FM1, FM2, FM3). You can use any one of them to listen to an FM broadcast.

2 Start searching a station.

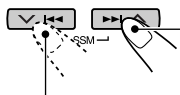

Press to search stations of higher frequencies.

Press to search stations of lower frequencies.

When a station is received, searching stops.

To stop searching before a station is received, press the same button you have pressed for searching.

To turn in FM stations only with strong signals

1 Press M/B (mode/band) to enter the functions mode while listening to an FM broadcast and then, the number buttons can work as different function buttons. (See page 4.)

2 Press LO (local) while still in the functions mode, so that the LOCAL indicator lights up on the display.

This function works only while searching FM stations, including SSM preset. Each time you press the button, the LOCAL indicator lights up and goes off alternately.

Searching a station manually: Manual search

1 Select the FM or AM.

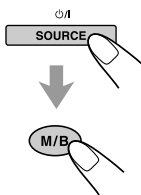

1 Press SOURCE repeatedly to select FM or AM as the source.

2 If necessary, to select the FM band number, press and hold M/B (mode/band) for more than 1 second repeatedly. Each time you press and hold the button, the FM band changes as follows:

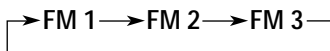

Note:

This receiver has three FM bands (FM1, FM2, FM3). You can use any one of them to listen to an FM broadcast.

2 Press and hold **▶▶|** **^** or **∨|◀◀** until “M” (manual) starts flashing on the display.

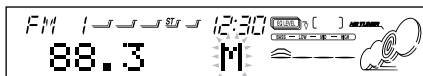

3 Tune into a station you want while “M” is flashing.

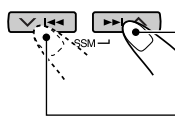

Press **▶▶|** **^** to tune into stations of higher frequencies.

Press **∨|◀◀** to tune into stations of lower frequencies.

- If you release your finger from the button, the manual mode will automatically turn off after 5 seconds.
- If you hold down the button, the frequency keeps changing until you release the button.

Storing stations in memory

You can use one of the following two methods to store broadcasting stations in memory.

- Automatic preset of FM stations: SSM (Strong-station Sequential Memory)
- Manual preset of both FM and AM stations

FM station automatic preset: SSM

You can preset 6 local FM stations in each FM band (FM1, FM2 and FM3).

1 Select the FM band (FM1 – 3) you want to store FM stations into.

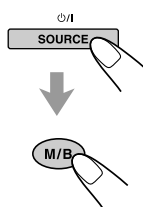

- 1 Press SOURCE repeatedly to select FM.
- 2 If necessary, press and hold M/B (mode/band) for more than 1 second repeatedly. Each time you press and hold the button, the FM band changes as follows:

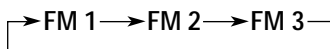

2 Press and hold both buttons for more than 2 seconds.

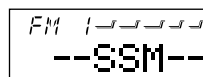
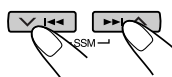

“SSM” appears, then disappears when automatic preset is over.

Local FM stations with the strongest signals are searched and stored automatically in the band number you have selected (FM1, FM2 or FM3). These stations are preset in the number buttons — No. 1 (lowest frequency) to No. 6 (highest frequency).

When automatic preset is over, the station stored in number button 1 will be automatically tuned in.

When an FM stereo broadcast is hard to receive:

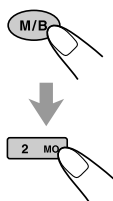

- 1 Press M/B (mode/band) to enter the functions mode while listening to an FM stereo broadcast.
 - 2 Press MO (monaural), while still in the functions mode, so that the MO indicator lights up on the display.
- Each time you press the button, the MO indicator lights up and goes off alternately.

Lights up when receiving an FM broadcast in stereo.

The MO indicator lights up.

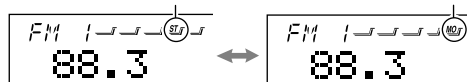

When the MO indicator is lit on the display, the sound you hear becomes monaural but the reception will be improved (the ST indicator goes off).



Manual preset

You can preset up to 6 stations in each band (FM1, FM2, FM3 and AM) manually.
 Ex.: Storing an FM station of 88.3 MHz into the preset number 1 of the FM1 band

1 Select the band (FM1–3, AM) you want to store stations into (in this example, FM1).

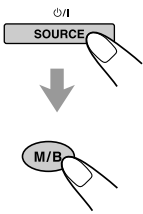

- 1 Press SOURCE repeatedly to select FM or AM as the source.
- 2 If necessary, to select the FM band number, press and hold M/B (mode/band) for more than 1 second repeatedly. Each time you press and hold the button, the FM band changes as follows:

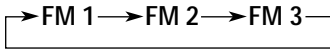

2 Tune into a station of 88.3 MHz.

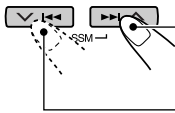

Press to tune into stations of higher frequencies.

Press to tune into stations of lower frequencies.

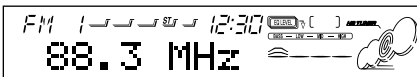

3 Press and hold the number button (in this example, 1) for more than 2 seconds.

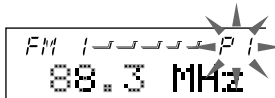

"P1" flashes for a while.

4 Repeat the above procedure to store other stations into other preset numbers.

Notes:

- A previously preset station is erased when a new station is stored in the same preset number.
- Preset stations are erased when the power supply to the memory circuit is interrupted (for example, during battery replacement). If this occurs, preset the stations again.

Tuning into a preset station

You can easily tune into a preset station. Remember that you must store stations first. If you have not stored them yet, see "Storing stations in memory" on page 9.

1 Select the FM or AM.

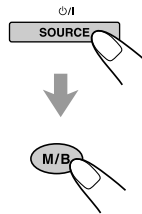

- 1 Press SOURCE repeatedly to select FM or AM as the source.
- 2 If necessary, to select the FM band number, press and hold M/B (mode/band) for more than 1 second repeatedly. Each time you press and hold the button, the FM band changes as follows:



2 Select the number (1 – 6) for the preset station you want.

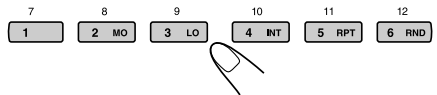

If the sound quality decreases and the stereo effect is lost while listening to an FM station

In some areas, adjacent stations may interfere with each other. If this interference occurs, this unit can automatically reduce this interference noise (the initial setting when shipped from the factory). However, in this case, the sound quality will be degraded and the stereo effect will be also lost.

If you do not want to degrade the sound quality and to lose the stereo effect, rather than to eliminate the interference noise, see "To change the FM tuner selectivity – IF FILTER" on page 26.



What you can do with RDS EON

RDS (Radio Data System) allows FM stations to send an additional signal along with their regular programme signals. For example, the stations send their station names, as well as information about what type of programme they broadcast, such as sports or music, etc.

Another advantage of RDS function is called “EON (Enhanced Other Networks).” The EON indicator lights up while receiving an FM station with the EON data. By using the EON data sent from a station, you can tune into a different station of a different network broadcasting your favorite programme or traffic announcement while listening to another programme or to another source such as CD.

By receiving the RDS data, this unit can do the following:

- Tracing the same programme automatically (Network-Tracking Reception)
- Standby Reception of TA (Traffic Announcement) or your favorite programme
- PTY (Programme Type) search
- Programme search
- And some other functions

Tracing the same programme automatically (Network-Tracking Reception)

When driving in an area where FM reception is not good, the tuner built in this unit automatically tunes into another RDS station, broadcasting the same programme with stronger signals. So, you can continue to listen to the same programme in its finest reception, no matter where you drive. (See the illustration on the next page.)

Two types of the RDS data are used to make Network-Tracking Reception work correctly — PI (Programme Identification) and AF (Alternative Frequency).

Without receiving these data correctly from the RDS station you are listening to, Network-Tracking Reception will not operate.

To use **Network-Tracking Reception**, press and hold TP (traffic programme) for more than 1 second. Each time you press and hold the button, Network-Tracking Reception modes change as follows:

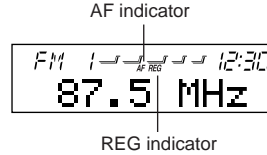
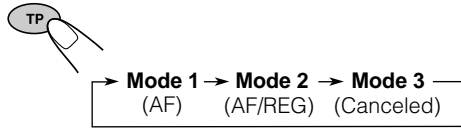

○: lights ✕: goes off

	AF indicator	REG indicator
Mode 1	○	✕
Mode 2	○	○
Mode 3	✕	✕

Mode 1

Network-Tracking Reception is activated with Regionalization set to “off.”

Switches to another station within the same network when the receiving signals from the current station become weak.

- *In this mode, the programme may differ from the one currently received.*

Mode 2

Network-Tracking Reception is activated with Regionalization set to “on.”

Switches to another station, within the same network, broadcasting the same programme when the receiving signals from the current station become weak.

Mode 3

Network-Tracking Reception is deactivated.

Note:

If a DAB tuner is connected and Alternative Reception (for DAB services) is activated, Network-Tracking Reception is also activated automatically. On the other hand, Networking-Tracking Reception cannot be deactivated without deactivating Alternative Reception. (See page 37.)



The same programme can be received on different frequencies.

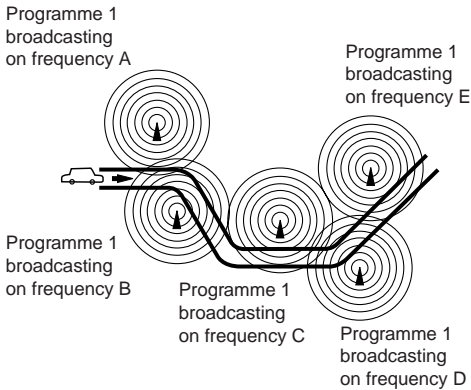

Using Standby Reception

Standby Reception allows the unit to switch temporarily to your favorite programme (PTY: Programme Type) and Traffic Announcement (TA) from the current source (another FM station, CD or other connected components).

- *Standby Reception will not work if you are listening to an AM station.*

TA Standby Reception

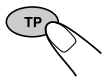

When you press TP while listening to an FM station, the TP indicator is lit during reception of a TP (Traffic Programme) station and the TA standby mode is engaged.

- *When the station being received is not a TP station, the TP indicator flashes. Press ►►|▲ or ▼|◄◄ to engage the TA standby mode. “SEARCH” appears on the display, and TP station search starts. When a TP station is tuned into, the TP indicator is lit.*
- If you are listening to a CD or other connected components and wish to listen to a TP station, press TP to enter the TA standby mode. (The TP indicator lights up.)

If a traffic programme starts broadcasting while the TA standby mode is active, “TRAFFIC” appears and the playback source changes to the FM band. The volume increases to the preset TA volume level (see page 15) and the traffic programme can be heard.

To deactivate the TA standby mode, press TP again.

PTY Standby Reception



When you press PTY while listening to an FM station, the PTY indicator is lit during reception of a PTY station and the PTY standby mode is engaged. The selected PTY name stored on page 13 flashes for 5 seconds.

- *When the station being received is not a PTY station, the PTY indicator flashes. Press ►►|▲ or ▼|◄◄ to engage the PTY standby mode. “SEARCH” appears on the display, and PTY station search starts. When a PTY station is tuned into, the PTY indicator is lit.*
- If you are listening to a CD or other connected components and wish to listen to a selected PTY broadcast, press PTY to enter the PTY standby mode. (The PTY indicator lights up.)

If the selected PTY programme starts broadcasting while the PTY standby mode is active, the selected PTY name appears and the playback source changes to the FM band. The selected PTY programme can then be heard.

To deactivate the PTY standby mode, press PTY again.



Selecting your favorite programme for PTY Standby Reception

You can select your favorite programme for PTY Standby Reception to store in memory. When shipped from the factory, "NEWS" is stored as the programme type for PTY Standby Reception.

- 1 Press and hold SEL (select) for more than 2 seconds so that one of the PSM items appears on the display. (PSM: see page 24.)



- 2 Select "PTY STBY" (standby) if not shown on the display.

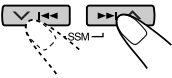

- 3 Select one of twenty-nine PTY codes. (See page 16.)

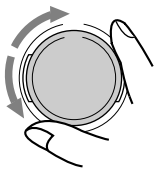

Selected code name appears on the display and is stored into memory.

- 4 Press SEL (select) to finish the setting.



Searching your favorite programme

You can search one of your 6 favorite programme types stored in memory. When shipped from the factory, the following 6 programme types have been stored in the number buttons (1 to 6).

To store your favorite programme types, see below.

To search your favorite programme type, see page 14.

1	2	3
POP M	ROCK M	EASY M
4	5	6
CLASSICS	AFFAIRS	VARIED

To store your favorite programme types

- 1 Press and hold SEL (select) for more than 2 seconds so that one of the PSM items appears on the display. (PSM: see page 24.)



- 2 Select "PTY SEARCH" if not shown on the display.

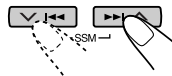

- 3 Select one of twenty-nine PTY codes. (See page 16.)



Selected code name appears on the display.

- If the code already stored in memory is selected, it will flash on the display.



4 Press and hold the number button for more than 2 seconds to store the PTY code selected into the preset number you want.

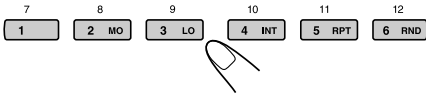

"MEMORY" and the selected code name will flash alternately and then only the selected code name will continue flashing on the display.

5 Press SEL (select) to finish the setting.



To search your favorite programme type

1 Press and hold PTY (programme type) for more than 1 second while listening to an FM station.

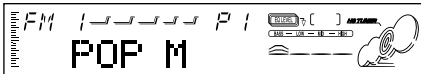
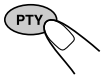

The last selected PTY code appears.

2 Select one of the PTY codes stored in the preset number buttons (1 to 6).

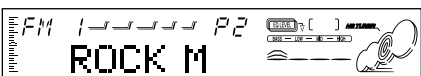
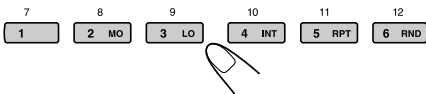

Ex.: When "ROCK M" is stored in preset number button 2

PTY search for your favorite programme starts after 5 seconds.

- If there is a station broadcasting a programme of the same PTY code as you selected, that station is tuned into.
- If there is no station broadcasting a programme of the same PTY code as you selected, the station will not change.

Note:

In some areas, the PTY search will not work correctly.

Other convenient RDS functions and adjustments

Automatic selection of the station when using the number buttons

Usually when you press the number button, the preset station is tuned into. However, when the preset station is an RDS station, something different will happen. If the signals from that preset station are not sufficient for good reception, this unit, using the AF data, tunes into another frequency broadcasting the same programme as the original preset station is broadcasting. (Programme search)

- The unit takes some time to tune into another station using programme search.

To activate programme search, follow the procedure below.

- See also "Changing the general settings (PSM)" on page 23.

- 1 Press and hold SEL (select) for more than 2 seconds so that one of the PSM items appears on the display.
- 2 Press **▶▶** **▲** or **▼** **◀◀** to select "P-SEARCH."
- 3 Turn the control dial clockwise to select "SEARCH ON."
Now programme search is activated.
- 4 Press SEL (select) to finish the setting.

To cancel programme search, repeat the same procedure and select "SEARCH OFF" in step 3 by turning the control dial counterclockwise.



Changing the display mode while listening to an FM station

You can change the initial indication on the display to station name (PS NAME) or station frequency (FREQUENCY) while listening to an FM RDS station.

- See also “Changing the general settings (PSM)” on page 23.
- 1 Press and hold SEL (select) for more than 2 seconds so that one of the PSM items appears on the display.
 - 2 Press ►►|▲ or ▼|◄◄ to select “TUNER DISP” (tuner display).
 - 3 Turn the control dial to set to the desired indication (“FREQUENCY” or “PS NAME”).
 - 4 Press SEL (select) to finish the setting.

Note:

By pressing D (display), you can change the display while listening to an FM RDS station only.

Each time you press the button, the following information appears on the display:

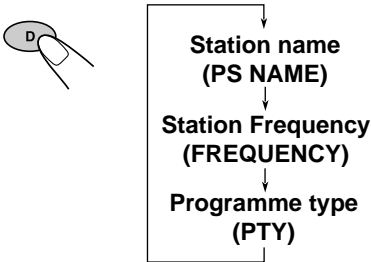

- Then, the display goes back to the original indication in several seconds.

Setting the TA volume level

You can preset the volume level for TA Standby Reception. When a traffic programme is received, the volume level automatically changes to the preset level.

- See also “Changing the general settings (PSM)” on page 23.
- 1 Press and hold SEL (select) for more than 2 seconds so that one of the PSM items appears on the display.
 - 2 Press ►►|▲ or ▼|◄◄ to select “TA VOL.”
 - 3 Turn the control dial to set to the desired volume. You can set it from “TA VOL 00” to “TA VOL 50.”
 - 4 Press SEL (select) to finish the setting.

Automatic clock adjustment

When shipped from the factory, the clock built in this unit is set to be readjusted automatically using the CT (Clock Time) data in the RDS signal.

If you do not want to use automatic clock adjustment, follow the procedure below.

- See also “Changing the general settings (PSM)” on page 23.
- 1 Press and hold SEL (select) for more than 2 seconds so that one of the PSM items appears on the display.
 - 2 Press ►►|▲ or ▼|◄◄ to select “AUTO ADJ.”
 - 3 Turn the control dial counterclockwise to select “ADJUST OFF.”
Now automatic clock adjustment is canceled.
 - 4 Press SEL (select) to finish the setting.

To reactivate clock adjustment, repeat the same procedure and select “ADJUST ON” in step 3 by turning the control dial clockwise.

Note:

You must stay tuned to the same station for more than 2 minutes after setting “AUTO ADJ” to “ADJUST ON.” Otherwise, the clock time will not be adjusted. (This is because the unit takes up to 2 minutes to capture the CT data in the RDS signal.)



PTY codes

NEWS:	News	SOCIAL:	Programmes on social activities
AFFAIRS:	Topical programmes expanding on current news or affairs	RELIGION:	Programmes dealing with any aspect of belief or faith, or the nature of existence or ethics
INFO:	Programmes which impart advice on a wide variety of topics	PHONE IN:	Programmes where people can express their views either by phone or in a public forum
SPORT:	Sport events	TRAVEL:	Programmes about travel destinations, package tours, and travel ideas and opportunities
EDUCATE:	Educational programmes	LEISURE:	Programmes concerned with recreational activities such as gardening, cooking, fishing, etc.
DRAMA:	Radio plays	JAZZ:	Jazz music
CULTURE:	Programmes on national or regional culture	COUNTRY:	Country music
SCIENCE:	Programmes on natural science and technology	NATION M:	Current popular music from another nation or region, in that country's language
VARIED:	Other programmes like comedies or ceremonies	OLDIES:	Classic pop music
POP M:	Pop music	FOLK M:	Folk music
ROCK M:	Rock music	DOCUMENT:	Programmes dealing with factual matters, presented in an investigative style
EASY M:	Easy-listening music		
LIGHT M:	Light music		
CLASSICS:	Classical music		
OTHER M:	Other music		
WEATHER:	Weather information		
FINANCE:	Reports on commerce, trading, the Stock Market, etc.		
CHILDREN:	Entertainment programmes for children		

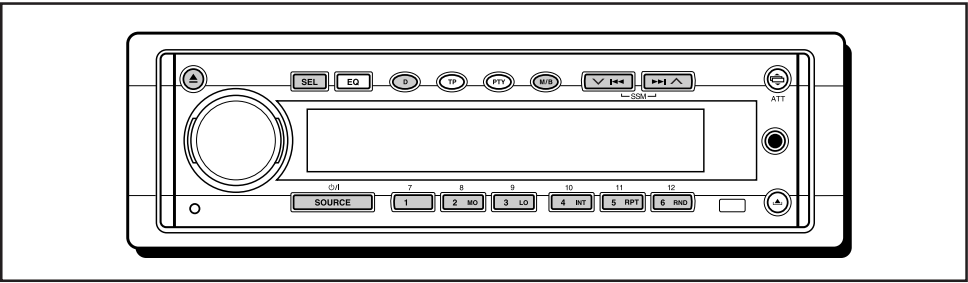

Playing a CD

1 Open the loading slot.



The control panel moves down, and the loading slot appears.

Note:

When an external component is connected to the Auxiliary input jack, Be careful of handling a CD.

2 Insert a disc into the loading slot.

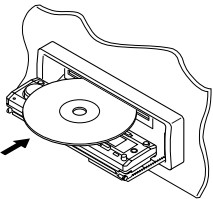

The unit draws a CD, the control panel goes back to the previous position (see page 28), and CD play starts automatically.

The display changes to show the following:

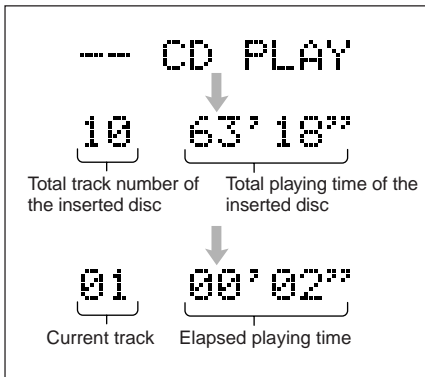

Notes:

- When a CD is in the loading slot, selecting "CD" as the source by pressing SOURCE starts CD play.
- When a CD is inserted upside down, the CD automatically ejects.
- When you play a CD Text, the disc title and performer appear on the display. Then the current track title appears on the display, followed by the track number and elapsed playing time. See also "Playing a CD Text" (page 18) and "To select the scroll mode – SCROLL" (page 25).
If a CD Text includes much text information, some may not appear on the display.
- If you change the source, CD play also stops (without ejecting the CD).

To stop play and eject the CD

Press ▲.

CD play stops, the control panel moves down, then the CD automatically ejects from the loading slot.

To return the control panel to the previous position, press ▲ again.

- If you keep the loading slot for one minute (or 30 seconds when you have ejected a disc with the ignition key is turned to "OFF") a beep sounds and the control panel returns to the previous position.

Pay attention to prevent CD and your finger from being caught in between the control panel and the unit.

Note:

If the ejected disc is not removed for about 15 seconds, the disc is automatically inserted again into the loading slot to protect it from dust. (CD play will not start this time.)



Playing a CD Text

In a CD Text, some information about the disc (its disc title, performer and track title) is recorded. You can show these disc information on the display.

1 Select text display mode while playing a CD Text.



Each time you press the button, the display changes as follows:



Notes:

- The display shows up to 10 characters at one time and scrolls if there are more than 10 characters. See also "To select the scroll mode – SCROLL" on page 25.
- When you press D (display) while playing a conventional CD, "NO NAME" appears for the disc title/performer and the track title.

Locating a track or particular portion on a CD

To fast-forward or reverse the track

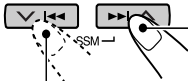

Press and hold **▶▶** **▲**, while playing a CD, to fast-forward the track.

Press and hold **◀◀** **▼**, while playing a CD, to reverse the track.

To go to the next track or the previous tracks

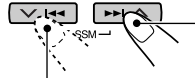

Press **▶▶** **▲** briefly, while playing a CD, to go ahead to the beginning of the next track. Each time you press the button consecutively, the beginning of the next track is located and played back.

Press **◀◀** **▼** briefly, while playing a CD, to go back to the beginning of the current track. Each time you press the button consecutively, the beginning of the previous tracks is located and played back.

To go to a particular track directly

Press the number button corresponding to the track number to start its playback.

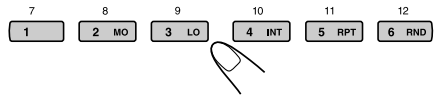

- To select a track number from 1 – 6: Press 1 (7) – 6 (12) briefly.
- To select a track number from 7 – 12: Press and hold 1 (7) – 6 (12) for more than 1 second.

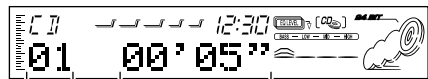

Track number Elapsed playing time



Selecting CD playback modes

To play back tracks at random (Random Play)

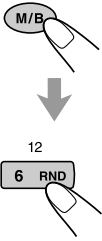

- 1 Press M/B (mode/band) to enter the functions mode while playing a CD. This unit enters the functions mode.
- 2 Press RND (random), while still in the functions mode, so that the RND indicator lights up on the display. Then, each time you press the button, CD random play mode turns on and off alternately.



When the random mode is turned on, the RND indicator lights up on the display and a track randomly selected starts playing.

To play back tracks repeatedly (Repeat Play)

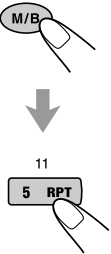

- 1 Press M/B (mode/band) to enter the functions mode while playing a CD. This unit enters the functions mode.
- 2 Press RPT (repeat), while still in the functions mode, so that the RPT indicator lights up on the display. Then, each time you press the button, CD repeat play mode turns on and off alternately.



To play back tracks repeatedly (Intro scan)

You can playback the first 15 seconds of each track sequentially.

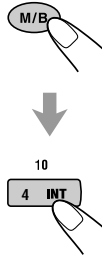

- 1 Press M/B (mode/band) to enter the functions mode while playing a CD. This unit enters the functions mode.
- 2 Press INT (intro scan), while still in the functions mode, so that the "INTRO" appears on the display. Then, each time you press the button, CD intro scan play mode turns on and off alternately.



Track number of the currently playing track

Prohibiting CD ejection

You can prohibit CD ejection and can lock a CD in the loading slot.

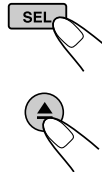

While pressing SEL (select), press and hold ▲ for more than 2 seconds. "NO EJECT" flashes on the display for about 5 seconds, and the CD is locked and cannot be ejected.



Note:

If you press ▲ while CD ejection is prohibited, the control panel moves down, but the CD cannot be ejected.

To return the display panel, to the previous position, press ▲.

To cancel the prohibition and unlock the CD, press and hold ▲ for more than 2 seconds again, while pressing SEL.

"EJECT OK" flashes on the display for about 5 seconds, and the CD is unlocked.



SOUND ADJUSTMENTS

Adjusting the sound

You can adjust the sound characteristics to your preference.

1 Select the item you want to adjust.



Each time you press the button, the adjustable items change as follows:

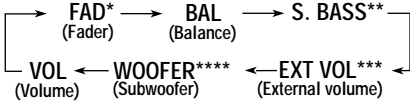

2 Adjust the level.

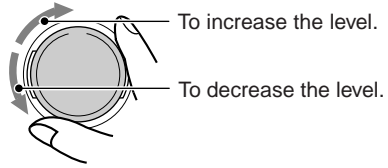

Note:

Normally, the control dial works as the volume control. So you do not have to select "VOL" to adjust the volume level.

Indication	To do:	Range
FAD*	Adjust the front and rear speaker balance.	R06 (Rear only) F06 (Front only)
BAL	Adjust the left and right speaker balance.	L06 (Left only) R06 (Right only)
S. BASS**	Adjust the bass.	00 (min.) 08 (max.)
EXT VOL***	Adjust the output level through the EXT OUT plugs.	00 (min.) 12 (max.)
WOOFER****	Adjust the subwoofer output level.	00 (min.) 12 (max.)
VOL	Adjust the volume.	00 (min.) 50 (max.)

* If you are using a two-speaker system, set the fader level to "00."

** The richness and fullness of the bass sound is clearly maintained regardless of how low you set the volume – Super Bass.
You can also adjust the level of Super Bass.

*** ONLY for KD-SH55R: This takes effect only when the amplifier(s) or other component(s) are connected to the EXT OUT plugs.

**** ONLY for KD-SH77R: This takes effect only when a subwoofer is connected.



Selecting preset sound modes

You can select a preset sound mode suitable to the music genre.

1 Press EQ.

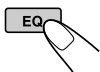

The last selected sound mode is recalled, and it is applied to the current source.

The EQ indicator lights up.

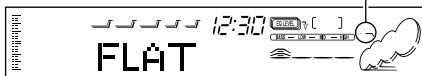

Ex.: When you have selected "FLAT" previously

2 Select the sound mode you want.

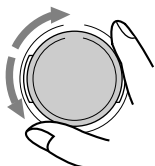

As you turn the control dial, the sound modes change as follows:

FLAT ⇄ Hard Rock ⇄ R & B* ⇄ POP ⇄
JAZZ ⇄ DanceMusic ⇄ Country ⇄ Reggae ⇄
Classic ⇄ USER 1 ⇄ USER 2 ⇄ USER 3 ⇄
(back to the beginning)

* Rhythm and Blues

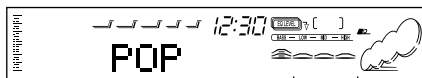

EQ level changes as you select the sound mode.

Ex.: When you select "POP"

To cancel the sound mode, select "FLAT" in step 2.

Notes:

- You can adjust each sound mode to your preference, and store it in memory.
If you want to adjust and store your original sound mode, see "Storing your own sound adjustments" on page 22.
- To adjust the bass reinforcement level temporarily, see page 20.

To store a sound mode separately for each playback source (EQ Link)

Once you select a sound mode, it is stored in memory. It will be recalled every time you select the same source.

A sound mode can be stored for each of the following sources — FM1, FM2, FM3, AM, CD and external components.

- See also "Changing the general settings (PSM)" on page 23.

- Press and hold SEL (select) for more than 2 seconds so that one of the PSM items appears on the display.
- Press ►►| ^ or ▼ |◄◄ to select "EQ LINK" (Equalization Link).
- Turn the control dial clockwise to select "LINK ON."
- Press SEL (select) to finish the setting.

To cancel EQ Link, repeat the same procedure and select "LINK OFF" by turning the control dial counterclockwise in step 3.

- When "EQ LINK" is set to "LINK ON"**
The selected sound mode can be stored in memory for the current source.
Each time you change the same source, the same sound mode is also recalled, and shown after the source name.
- When "EQ LINK" is set to "LINK OFF"**
The selected sound mode effect applies to all the sources selected.



Storing your own sound adjustments

You can adjust the sound modes to your preference and store your own adjustments in memory (USER 1, USER 2 and USER 3)

- There is a time limit in doing the following procedure. If the setting is canceled before you finish, start from step 1 again.

1 Press EQ.

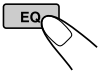

The last selected sound mode is recalled, and it is applied to the current source.

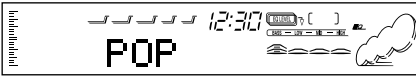

Ex.: When you have selected "POP" previously

2 Press SEL (select) to select sound elements to adjust.



Each time you press the button, the sound elements to adjust change as follows:

LOW FREQ.* → LOW WIDTH → LOW LEVEL →
 MID FREQ.* → MID WIDTH → MID LEVEL →
 HIGH FREQ.* → HIGH LEVEL →
 (back to the beginning)

FREQ. (LOW, MID, HIGH):

Select the center frequency to adjust.

WIDTH (LOW, MID):

Select the band width level (Q).

LEVEL (LOW, MID, HIGH):

Adjust the enhancement level.

* By pressing ►►► ▲ or ▼ ◄◄◄, you can directly move as follows:

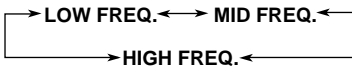

3 Adjust the selected sound element.

- Refer to the table below for adjusting the selected sound element.

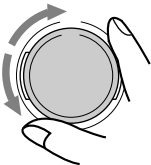

4 Repeat step 2 and 3 to adjust the other sound elements.

5 Select one of the user sound modes (USER1, USER2, USER3).



Ex.: When you select "USER 2"

6 Press EQ to store the adjustments.



To reset to the factory settings

Repeat the same procedure and reassign the preset values listed in the table on page 38.

Indication	Preset values		
	LOW	MID	HIGH
FREQ.	50 Hz 80 Hz 120 Hz	700 Hz 1 kHz 2 kHz	8 kHz 12 kHz
WIDTH	1 (min.) 4 (max.)	1 (min.) 2 (max.)	_____
LEVEL	-06 (min.) +06 (max.)	-06 (min.) +06 (max.)	-06 (min.) +06 (max.)

Setting the clock

- 1 Press and hold SEL (select) for more than 2 seconds so that one of the PSM items appears on the display. (See page 24.)



- 2 Set the hour.

- 1 Select "CLOCK HOUR" if not shown on the display.
- 2 Adjust the hour.

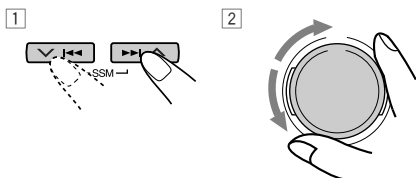

- 3 Set the minute.

- 1 Select "CLOCK MIN."
- 2 Adjust the minute.

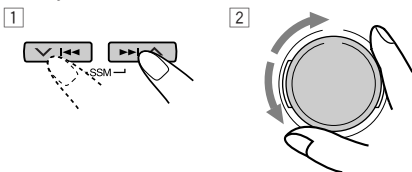

- 4 Select the clock system.

- 1 Select "24H/12H."
- 2 Select either "12HOUR" or "24HOUR."

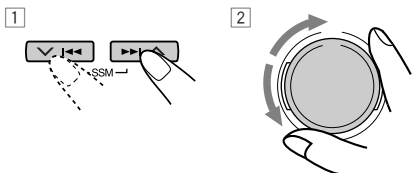

- 5 Press SEL (select) to finish the setting.



To check the current clock time while the unit is turned off, press D (display).

The power turns on, the clock time is shown for 5 seconds, then the power turns off.

Changing the general settings (PSM)

You can change the items listed on the next page by using the PSM (Preferred Setting Mode) control.

Basic Procedure

- 1 Press and hold SEL (select) for more than 2 seconds so that one of the PSM items appears on the display. (See page 24.)



- 2 Select a PSM item you want to adjust. (See page 24.)

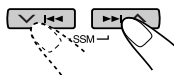

- 3 Adjust the PSM item selected.

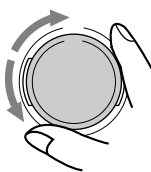

- 4 Repeat steps 2 and 3 to adjust the other PSM items if necessary.

- 5 Press SEL (select) to finish the setting.

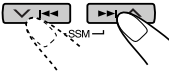
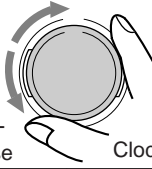

Preferred Setting Mode (PSM) items

<div style="display: flex; justify-content: space-around;"> <div style="text-align: center;"> 1  Hold. </div> <div style="text-align: center;"> 2  Select. </div> <div style="text-align: center;"> 3 Set.  Counter-clockwise Clockwise </div> </div>		Factory-preset settings	See page	
CLOCK HOUR	Hour adjustment	Back Advance		
CLOCK MIN	Minute adjustment	Back Advance	0:00	23
EQ LINK	Sound control memory linkage	LINK OFF LINK ON	LINK OFF	21
24H/12H	24/12-hour time display	12HOUR 24HOUR	24HOUR	23
AUTO ADJ	Automatic clock setting	ADJUST OFF ADJUST ON	ADJUST ON	15
CLOCK DISP	Clock display	CLOCK OFF CLOCK ON	CLOCK ON	25
TUNER DISP	Tuner display	FREQUENCY PS NAME	PS NAME	15
PTY STBY	PTY standby	29 program types (See pages 13 and 16.)		13
PTY SEARCH	PTY search			
TA VOL	Traffic announcement volume	TA VOL 00 – TA VOL 50	TA VOL 20	15
P-SEARCH	Programme search	SEARCH OFF SEARCH ON	SEARCH OFF	14
DAB AF*	Alternate frequency search	AF OFF AF ON	AF ON	37
LEVEL/EQ	Equalizer/Level indicator	EQ ONLY ↔ LEVEL+EQ LEVEL ONLY ↗↘	EQ ONLY	25
DIMMER	Dimmer mode	AUTO ↔ OFF ↕ ON ↕	AUTO	25
TELEPHONE	Telephone muting	MUTING OFF ↔ MUTING1 ↕ MUTING2 ↕	MUTING OFF	25
BEEP SW	Key-touch tone	BEEP OFF BEEP ON	BEEP ON	25
P.AMP SW**	Power amplifier switch	P.AMP OFF P.AMP ON	P.AMP ON	25
CONTRAST	Display contrast	CONTRAST 1 – CONTRAST 10	CONTRAST 5	25
SCROLL	Scroll mode	ONCE ↔ AUTO ↕ OFF ↕	ONCE	25
CUTOFF F**	Subwoofer cutoff Frequency	FREQ MID ↔ FREQ HIGH ↕ FREQ LOW ↕	FREQ MID	25
LINE ADJ**	Line input level adjustment	L.ADJ 00 – L.ADJ 05	L.ADJ 00	26
EXT INPUT***	External input selection	CD CHANGER LINE INPUT	CD CHANGER	26
AUX ADJ	Auxiliary input level adjustment	A.ADJ 00 – A.ADJ 05	A.ADJ 00	26
KEY SELECT**	External key-operation mode selection	DVD ↔ VCR ↕ OFF ↕	DVD	26
IF FILTER	Intermediate frequency filter	WIDE AUTO	AUTO	26
DEMO MODE	Demonstration mode	DEMO OFF DEMO ON	DEMO ON	26

• Press SEL (select) to finish the setting.
 * Displayed only when the DAB tuner is connected.
 ** ONLY for KD-SH77R
 *** ONLY for KD-SH55R — Displayed only when one of the following sources is selected — FM, AM, CD and AUX INPUT.

To set the clock display – CLOCK DISP

You can set the clock to be shown on the display when the unit is turned on.

When shipped from the factory, the clock is set to be shown on the display.

- **CLOCK ON:** Clock display is turned on.
- **CLOCK OFF:** Clock display is turned off.

To select the level meter – LEVEL/EQ

You can select the level display according to your preference.

When shipped from the factory, this mode is set to "EQ ONLY."

- **EQ ONLY:** Equalizer pattern is displayed.
- **LEVEL+EQ:** Equalizer pattern is displayed along with audio level meter.
- **LEVEL ONLY:** Audio Level meter illuminates upward and downward from center.

To select the dimmer mode – DIMMER

When you turn on the car head lights, the display automatically dims (Auto Dimmer).

When shipped from the factory, Auto Dimmer mode is activated.

- **AUTO:** Activates Auto Dimmer.
- **OFF:** Cancels Auto Dimmer.
- **ON:** Always dims the display.

Note:

Auto Dimmer equipped for this unit may not work correctly on some vehicles, particularly on those having a control dial for dimming.

In this case, set the dimmer mode to "ON" or "OFF."

To select the telephone muting – TELEPHONE

This mode is used when a cellular phone system is connected. Depending on the phone system used, select either "MUTING 1" or "MUTING 2," whichever mutes the sounds from this unit. When shipped from the factory, this mode is deactivated.

- **MUTING 1:** Select this if this setting can mute the sounds.
- **MUTING 2:** Select this if this setting can mute the sounds.
- **MUTING OFF:** Cancels the telephone muting.

To turn on/off the key-touch tone – BEEP SW

You can deactivate the key-touch tone if you do not want it to beep each time you press a button. When shipped from the factory, the key-touch tone is activated.

- **BEEP ON:** Activates the key-touch tone.
- **BEEP OFF:** Deactivates the key-touch tone.

To turn on/off the power amplifier switch – P. AMP SW. (For KD-SH77R only)

You can switch off the built-in amplifier and send the audio signals only to the external amplifier(s) to get clear sounds and to prevent internal heat buildup inside this unit.

When shipped from the factory, the power amplifier switch is turned on so that the built-in amplifier works.

- **P. AMP ON:** Select this mode when not using external amplifier(s).
- **P. AMP OFF:** Select this mode when using external amplifier(s).

To adjust the display contrast level – CONTRAST

You can adjust the display contrast level among 1 (dark) to 10 (bright). When shipped from the factory, the display contrast level is set at level 5.

To select the scroll mode – SCROLL

You can select the scroll mode for the disc information if it consists of more than 10 characters.

When shipped from the factory, Auto Scroll mode is set to "ONCE."

- **ONCE:** Scrolls only once.
- **AUTO:** Repeats the scroll (5-second intervals in between).
- **OFF:** Cancels Auto Scroll.

Note:

Even if the scroll mode is set to "OFF," you can scroll the display by pressing D (display) for more than 1 second.

To select the subwoofer cutoff frequency – CUTOFF F (For KD-SH77R only)

When a subwoofer is connected to this unit, select an appropriate cutoff frequency level for your subwoofer.

When shipped from the factory, the subwoofer cutoff frequency is set to "FREQ MID."

- **FREQ LOW:** Frequencies higher than 50 Hz are cut off to the subwoofer.
- **FREQ MID:** Frequencies higher than 80 Hz are cut off to the subwoofer.
- **FREQ HIGH:** Frequencies higher than 120 Hz are cut off to the subwoofer.

To adjust the line input level – LINE ADJ (For KD-SH77R only)

Adjust the line input level properly when an external component is connected to the LINE IN plugs.
When shipped from the factory, the line input level is set at level 00.
If the input level of the connected component is not high enough, increase the input level properly. Without adjusting the line input level, you may be surprised at a loud sound when you change the source from the external component to another source.

To select the external component to use – EXT INPUT (For KD-SH55R only)

You can connect the external component to the CD changer jack on the rear using the Line Input Adaptor KS-U57 (not supplied).
To use the external component as the playback source through this unit, you need to select which component – CD changer or external component – to use.
When shipped from the factory, CD changer is selected as the external component.

- LINE INPUT: To use the external component other than CD changer.
- CD CHANGER: To use the CD changer.

Note:
For connecting the Line Input Adaptor KS-U57 and the external component, refer to the Installation/Connection Manual (separate volume).

To adjust the auxiliary input level – AUX ADJ

Adjust the auxiliary input level properly when an external component is connected to the auxiliary input jack.
When shipped from the factory, the auxiliary input level is set at level 00.
If the input level of the connected component is not high enough, increase the input level properly. Without adjusting the line input level, you may be surprised at a loud sound when you change the source from the external component to another source.

To select the target component to operate through this receiver – KEY SELECT (For KD-SH77R only)

You can operate either JVC's VCR or DVD player through this receiver, by using the number buttons on the control panel.
When shipped from the factory, these number buttons are set to be used for the DVD operations. To use these number buttons on the control panel for DVD or VCR operations, see page 30.

To change the FM tuner selectivity – IF FILTER

In some areas, adjacent stations may interfere with each other. If this interference occurs, noise may be heard. This unit has been preset to automatically reduce this interference noise ("AUTO") when shipped from the factory.

- AUTO: When this type of interference occurs, this unit automatically increases the tuner selectivity so that interference noise will be reduced. (But the stereo effect will also be lost.)
- WIDE: Subject to the interference from adjacent stations, but sound quality will not be degraded and the stereo effect will not be lost.

To turn the demo mode on or off – DEMO MODE

You can turn the demo mode on or off. When shipped from the factory, "DEMO ON" is selected.

- DEMO ON: Turns the demo mode on. The demonstration will start automatically if no sound comes in for 3 minutes.
- DEMO OFF: Turns the demo mode off.

Note:
If the unit has been reset (and the power is on), demonstration will start if no sound comes in for about 10 seconds.

Assigning names to the sources

You can assign names to CDs and the external components.

After assigning a name, it will appear on the display when you select the source.

Sources	Maximum number of the characters
CDs *	up to 32 characters (up to 40 discs)
External components	up to 10 characters

* You cannot assign a name to a CD Text.

1 Select a source you want to assign a name to.

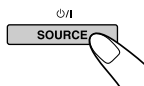

When you select a source, the power automatically comes on.

Each time you press the button, the source changes as described on page 7.

2 Press and hold SEL (select) for more than 2 seconds while pressing D (display).

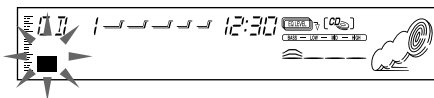
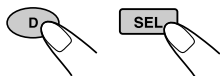

Ex.: When you select "CD PLAY" as the source

3 Select the character set you want while "D" is flashing.



Each time you press the button, the character set changes as follows:

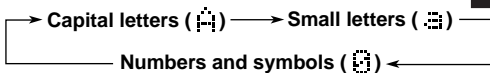

4 Select a character.

About the available characters, see page 38.

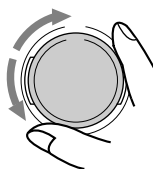

5 Move the cursor to the next (or previous) character position.

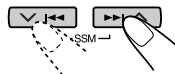

6 Repeat steps 3 to 5 until you finish inputting the name.

7 Finish the procedure while the last selected character is flashing.



To erase the input characters

Insert spaces using the same procedure described above.

Notes:

- When you try to assign a name to the 41st disc, "NAME FULL" appears on the display. (In this case, delete unwanted names before assignment.)
- When the CD changer is connected, you can assign names to CDs in the CD changer. These names can also be shown on the display if you insert the CDs in this unit.

Changing the control panel angle

You can change the angle of the control panel in three positions.

Adjust the angle to the position you want.



Each time you press the button, the panel angle changes as follows:

CAUTION:

NEVER insert your finger between the control panel and the unit, as it may get caught and hurt.

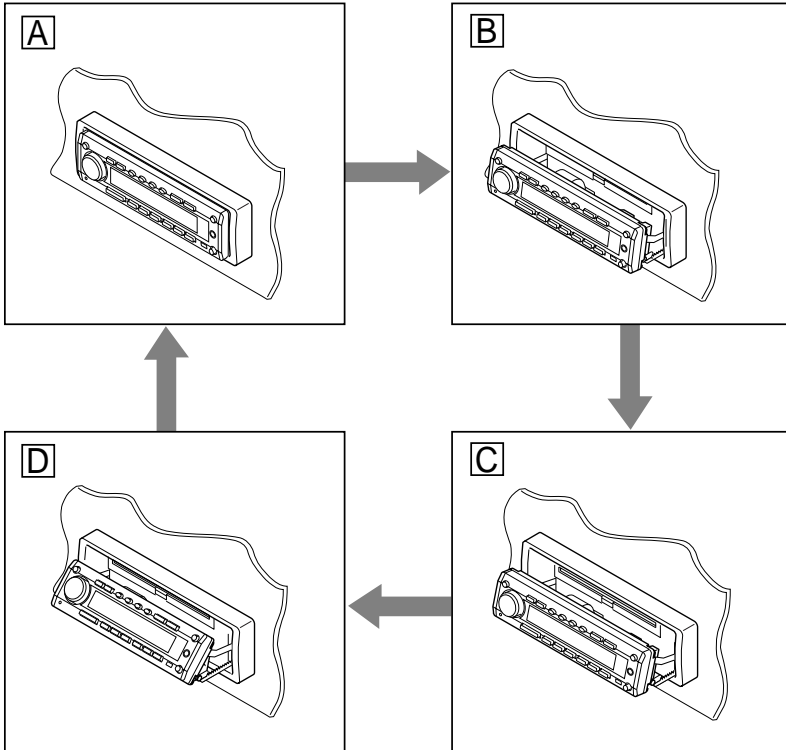
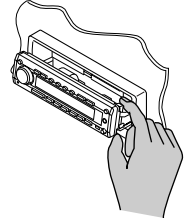

When using the remote controller

Press **ANGLE ▼** repeatedly. Each time you press the button, the control panel changes its angle — **A**, **B**, **C**, then **D** positions in sequence.

To restore the control panel to the original position,

press **ANGLE ▲**. Each time you press the button, the control panel reverses its angle — **D**, **C**, **B**, then **A** positions in sequence.

Detaching the control panel

You can detach the control panel when leaving the car.
When detaching or attaching the control panel, be careful not to damage the connectors on the back of the control panel and on the panel holder.

Detaching the control panel

Before detaching the control panel, be sure to turn off the power.

1 Unlock the control panel.

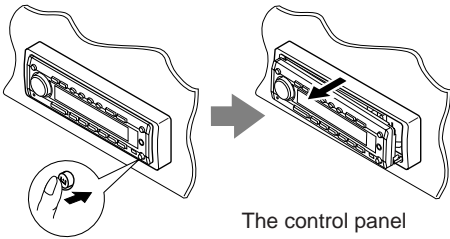

The control panel comes out toward you.

2 Move the control panel to the right, then pull it out of the unit.

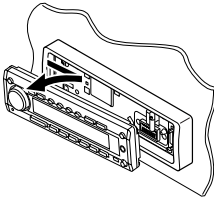

3 Put the detached control panel into the provided case.

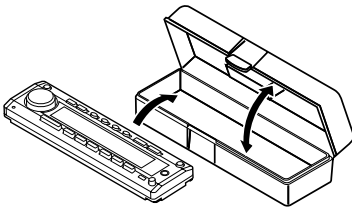

Attaching the control panel

1 Insert the left side of the control panel into the groove on the panel holder.

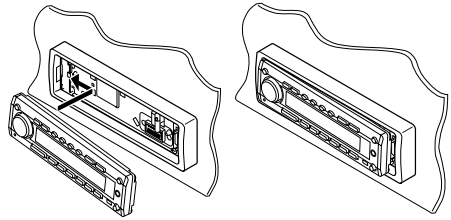

2 Press the right side of the control panel to fix it to the panel holder.

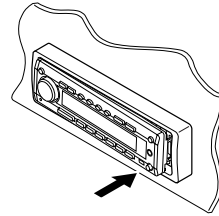

Note on cleaning the connectors:

If you frequently detach the control panel, the connectors will deteriorate.
To minimize this possibility, periodically wipe the connectors with a cotton swab or cloth moistened with alcohol, being careful not to damage the connectors.

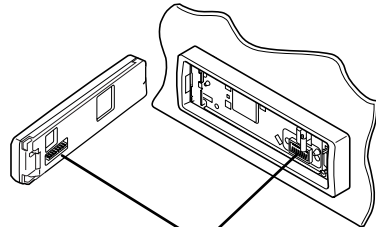

Connectors



EXTERNAL COMPONENT OPERATIONS

ENGLISH

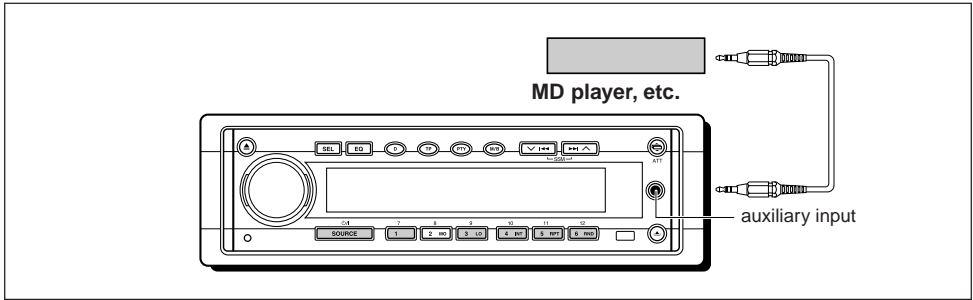

Playing external components

For KD-SH77R:

You can connect two external components to this unit.

Connect one to the auxiliary input jack on the control panel, and the other to the LINE IN plugs on the rear.

If you connect a JVC's VCR or DVD player to the LINE IN plugs

You can operate it through this receiver using the number buttons on the control panel. When you operate the VCR, you have to change the operation mode of the number buttons from the DVD operation mode to the VCR operation mode. (See "To select the target component to operate through this receiver – KEY SELECT" on page 26.)

If the input level of the external components is not high enough, increase the input level properly.

Without adjusting the input level, you may be surprised at a loud sound when you change the source from the external components to another. (See "To adjust the line input level – LINE ADJ" and "To adjust the auxiliary input level – AUX ADJ" on page 26.)

1 Select the external component (AUX INPUT or LINE INPUT).

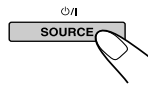

When you select a source, the power automatically comes on.

Each time you press the button, the source changes as described on page 7.

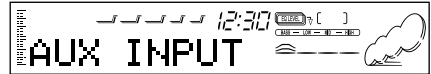

AUX INPUT: To select the component connected to the auxiliary input jack on the control panel

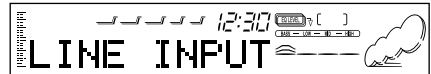

LINE INPUT: To select the component connected to the LINE IN plug

2 Turn on the connected component and start playing the source.

- If connecting a JVC's DVD player or VCR, you can perform the following operations.





When connecting a DVD player:

- ⏻/I : Turns on and off the power.
- ▶: Starts playback.
- ▶▶:
 - Fast-forward the track when pressed and held.
 - Skip to the beginning of the next tracks when pressed briefly.
- ◀◀:
 - Reverses the track when pressed and held.
 - Go back to the beginning of the current track when pressed briefly.
 - Go back to the beginning of the previous tracks when pressed consecutively.
- : Stops operations.

Note:

When you press the above buttons, the display shows “DVD” and its operation mode (such as ▶, ■).

When connecting a VCR:

- ⏻/I : Turns on and off the power.
- ▶: Starts playback.
- ▶▶: Fast-winds a tape when pressed and held.
- ◀◀: Rewinds a tape when pressed and held.
- : Stops operations.

Note:

When you press the above buttons, the display shows “VCR” and its operation mode (such as ▶, ■).

For KD-SH55R:

You can connect two external components to this unit.

Connect one to the auxiliary input jack on the control panel, and the other to the CD changer jack on the rear.

Before operating the external component connected to the CD changer jack, select the external input correctly. (See “To select the external component to use – EXT INPUT” on page 26.)

If the input level of the external component connected to the auxiliary input jack is not high enough, increase the input level properly.

Without adjusting the input level, you may be surprised at a loud sound when you change the source from the external component to another. (See “To adjust the auxiliary input level – AUX ADJ” on page 26.)

1 Select the external component (AUX INPUT or LINE INPUT).

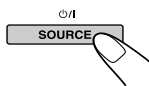

When you select a source, the power automatically comes on. Each time you press the button, the source changes as described on page 7.



AUX INPUT: To select the component connected to the auxiliary input jack on the control panel



LINE INPUT: To select the component connected to the CD changer jack

- If “LINE INPUT” cannot be selected, see page 26 and select the external input (“LINE INPUT”). This cannot be used together with the CD changer.

2 Turn on the connected component and start playing the source.



CD CHANGER OPERATIONS

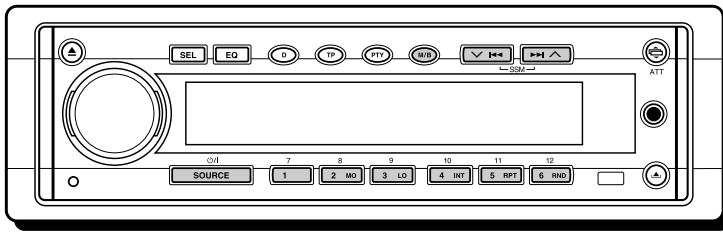

We recommend that you use one of the CH-X series with your unit.

If you have another CD automatic changer, consult your JVC IN-CAR ENTERTAINMENT for connections.

- For example, if your CD automatic changer is one of the KD-MK series, you need a cord (KS-U15K) for connecting it to this unit.

Before operating your CD automatic changer:

- Refer also to the Instructions supplied with your CD changer.
- If no discs are in the magazine of the CD changer or the discs are inserted upside down, "NO DISC" will appear on the display. If this happens, remove the magazine and set the discs correctly.
- If "RESET 1" – "RESET 8" appears on the display, something is wrong with the connection between this unit and the CD changer. If this happens, check the connection and make sure the cords are connected firmly. Then, press the reset button of the CD changer.

To fast-forward or reverse the track

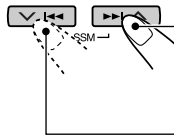

Press and hold **▶▶** **▲**, while playing a CD, to fast-forward the track.

Press and hold **▼** **◀◀**, while playing a CD, to reverse the track.

To go to the next track or the previous tracks

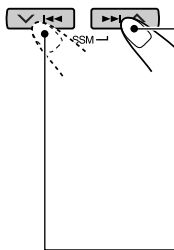

Press **▶▶** **▲** briefly, while playing a CD, to go ahead to the beginning of the next track. Each time you press the button consecutively, the beginning of the next track is located and played back.

Press **▼** **◀◀** briefly, while playing a CD, to go back to the beginning of the current track. Each time you press the button consecutively, the beginning of the previous tracks is located and played back.

Playing CDs

Select the CD automatic changer (CD CHANGER).

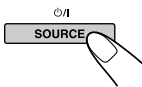

When you select a source, the power automatically comes on.

Each time you press the button, the source changes as described on page 7.

Disc number

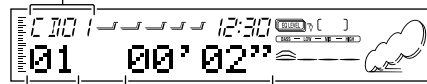

Track number Elapsed playing time

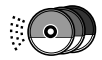

To go to a particular disc directly

Press the number button corresponding to the disc number to start its playback (while the CD changer is playing).



- To select a disc number from 1 – 6: Press 1 (7) – 6 (12) briefly.
- To select a disc number from 7 – 12: Press and hold 1 (7) – 6 (12) for more than 1 second.

Disc number

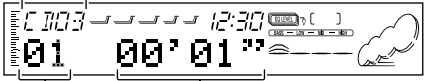

Track number Elapsed playing time

Ex.: When disc number 3 is selected

To play back tracks repeatedly (Repeat Play)

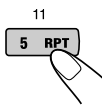
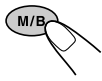

- 1 Press M/B (mode/band) while playing a CD. This unit enters the functions mode.
- 2 Press RPT (repeat), while still in the functions mode, so that the RPT indicator lights up on the display. Then, each time you press RPT, the repeat play mode changes as follows:

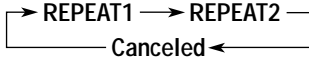

Mode	RPT Indicator	Plays repeatedly
REPEAT1	Lights	The current track (or specified track).
REPEAT2	Flashes	All tracks of the current disc (or specified disc).

Selecting CD playback modes

To play back tracks at random (Random Play)

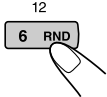
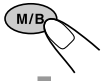

- 1 Press M/B (mode/band) while playing a CD. This unit enters the functions mode.
- 2 Press RND (random), while still in the functions mode, so that the RND indicator lights up on the display. Then, each time you press RND, the random play mode changes as follows:

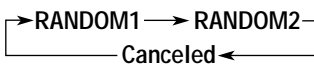

Mode	RND Indicator	Plays at random
RANDOM1	Lights	All tracks of the current disc, then the tracks of the next disc and so on.
RANDOM2	Flashes	All tracks of all discs inserted in the magazine.

To play back tracks repeatedly (Intro scan)

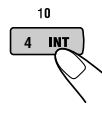

- 1 Press M/B (mode/band) while playing a CD. This unit enters the functions mode.
- 2 Press INT (intro scan), while still in the functions mode, so that "INTRO" appears on the display. Then, each time you press INT, the intro scan mode changes as follows:

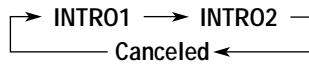

Mode	Indicator	Plays the beginnings (15 seconds)
INTRO1	Track number flashes	Of all tracks on all inserted disc.
INTRO2	Disc number flashes	Of the first track on each inserted disc.

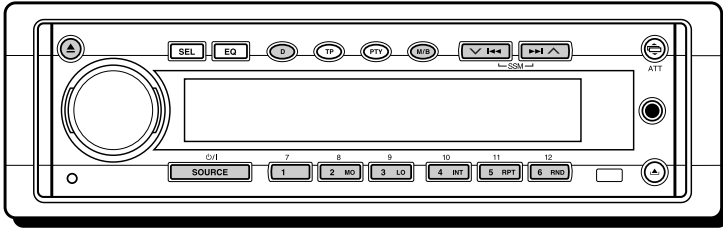

We recommend that you use DAB (Digital Audio Broadcasting) tuner KT-DB1500 with your unit. If you have another DAB tuner, consult your JVC IN-CAR ENTERTAINMENT dealer.

- Refer also to the Instructions supplied with your DAB tuner.

What is DAB system?

DAB is one of the digital radio broadcasting systems available today. It can deliver CD quality sound without any annoying interference and signal distortion. Furthermore, it can carry text, pictures and data.

In contrast to FM broadcast, where each programme is transmitted on its own frequency, DAB combines several programmes (called "services") to form one "ensemble."

With the DAB tuner connected with this unit, you can enjoy these DAB services.

Tuning into an ensemble and one of the services

A typical ensemble has 6 or more programmes (services) broadcast at the same time. After tuning into an ensemble, you can select a service you want to listen to.

1 Select the DAB tuner.

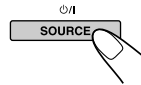

When you select a source, the power automatically comes on. Each time you press the button, the source changes as described on page 7.

2 Select the DAB band (DAB1, DAB2, or DAB3).

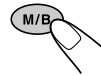

Each time you press and hold the button for more than 1 second, the DAB band changes as follows:



Note:

This receiver has three DAB bands (DAB 1, DAB 2, DAB 3). You can use any of them to tune into an ensemble.

3 Start searching an ensemble.

Press ►►| ^ to search ensembles of higher frequencies.

Press ▼|◄◄ to search ensembles of lower frequencies.

When an ensemble is received, searching stops.

To stop searching before an ensemble is received, press the same button you have pressed for searching.

4 Select a service you want to listen to.

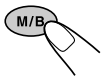

1 Press M/B (mode/band).

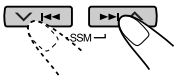

2 Press ►►| ^ or ▼ |◄◄ to select a service you want.

To change the display information while tuning into an ensemble

Normally service name is shown on the display. If you want to change the display information, press D (display).

Each time you press the button, the following information appears on the display for a while.

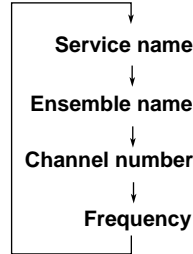

To tune into a particular ensemble without searching:

- 1 Press SOURCE to select DAB tuner as the source.
- 2 Press and hold M/B (mode/band) for more than 1 second repeatedly to select the DAB band (DAB 1, DAB 2 or DAB 3).
- 3 Press and hold ►►| ^ or ▼ |◄◄ for more than 1 second. "MANUAL" flashed on the display.
- 4 Press ►►| ^ or ▼ |◄◄ repeatedly until the ensemble you want is reached.
 - If you hold down the button, the ensembles keep changing until you release the button.

Storing DAB services in memory

You can preset up to 6 DAB services in each DAB band (DAB1, DAB2 and DAB3) manually.

1 Select the DAB tuner.

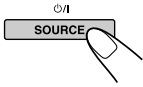

When you select a source, the power automatically comes on. Each time you press the button, the source changes as described on page 7.

2 Select the DAB band (DAB 1, DAB 2 or DAB 3) you want.

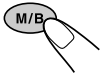

Each time you press and hold the button for more than 1 second, the DAB band changes as follows:



3 Tune into an ensemble you want.

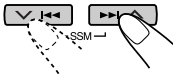

4 Select a service of the ensemble you want.



1 Press M/B (mode/band).

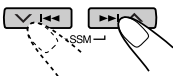

2 Press and hold or to select a service you want.

5 Press and hold the number button (in this example, 1) you want to store the selected service into for more than 2 seconds.

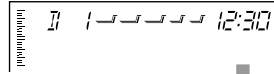

"P 1" flashes for a while.

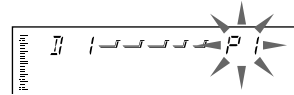

6 Repeat the above procedure to store other DAB services into other preset numbers.

Notes:

- A previously preset DAB service is erased when a new DAB service is stored in the same preset number.
- Preset DAB services are erased when the power supply to the memory circuit is interrupted (for example, during battery replacement). If this occurs, preset the DAB services again.

Tuning into a preset DAB service

You can easily tune into a preset DAB service. Remember that you must store services first. If you have not stored them yet, see page 36.

1 Select the DAB tuner.

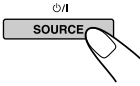

When you select a source, the power automatically comes on.

Each time you press the button, the source changes as described on page 7.

2 Select the DAB band (DAB1, DAB2 or DAB3) you want.

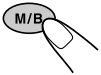

Each time you press and hold the button for more than 1 second, the DAB band changes as follows:

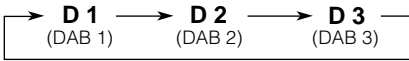

3 Select the number (1 – 6) for the preset DAB service you want.

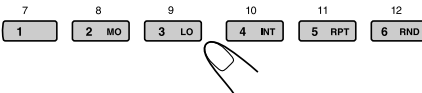

What you can do more with DAB

Tracing the same program automatically (Alternative Reception)

You can keep listening to the same program.

- **While receiving a DAB service:**

When driving in an area where a service cannot be received, this unit automatically tunes in another ensemble or FM RDS station, broadcasting the same program.

- **While receiving an FM RDS station:**

When driving in an area where a DAB service is broadcasting the same program as the FM RDS station is broadcasting, this unit automatically tunes into the DAB service.

Note:

When reception switches between DAB and FM, the listening volume level may increase or decrease inconveniently. This change in the volume level results from unequal audio injection levels at broadcaster site, but not from the malfunction of this unit.

To use Alternative Reception

When shipped from the factory, Alternative Reception is activated.

- See also “changing the general settings (PSM)” on page 23.

1 Press and hold SEL (select) for more than 2 seconds so that one of the PSM items appears on the display.

2 Press or to select “DAB AF” (alternative frequency).

3 Turn the control dial to select the desired mode.

- AF ON: Traces the program among DAB services and FM RDS stations — Alternative Reception. The AF indicator lights up on the display (see page 11).
- AF OFF: Deactivates Alternative Reception.

Note:

When Alternative Reception (for DAB services) is activated, Network-Tracking Reception (for RDS stations: see page 11) is also activated automatically. On the other hand, Network-Tracking Reception cannot be deactivated without deactivating Alternative Reception.

4 Press SEL (select) to finish the setting.



ADDITIONAL INFORMATION

ENGLISH

Sound modes (preset value settings)

The list below is the preset value settings for each sound mode.

Once you have changed their settings, you can reset to the factory settings by reassigning the preset values below. (See page 22 to reassignment procedure.)

Indication	Preset equalizing values							
	FREQ.	WIDTH	LOW LEVEL	FREQ.	WIDTH	MID LEVEL	FREQ.	HIGH LEVEL
FLAT	50 Hz	1	00	700 Hz	1	00	8 kHz	00
Hard Rock	80 Hz	2	+03	700 Hz	1	00	8 kHz	+02
R & B	80 Hz	3	+03	2 kHz	2	+01	12 kHz	+03
POP	120 Hz	1	+02	2 kHz	2	+01	12 kHz	+02
JAZZ	80 Hz	1	+03	1 kHz	1	+01	8 kHz	+03
DanceMusic	50 Hz	2	+04	700 Hz	1	-02	8 kHz	+01
Country	50 Hz	4	+02	700 Hz	1	00	12 kHz	+02
Reggae	80 Hz	1	+03	2 kHz	2	+02	12 kHz	+02
Classic	120 Hz	1	+03	1 kHz	1	00	8 kHz	+02
User 1	50 Hz	1	00	700 Hz	1	00	8 kHz	00
User 2	50 Hz	1	00	700 Hz	1	00	8 kHz	00
User 3	50 Hz	1	00	700 Hz	1	00	8 kHz	00

Available characters

You can use the following characters to assign names to CDs and external components. (See page 27.)

Capital letters

A	B	C	D	E
F	G	H	I	J
K	L	M	N	O
P	Q	R	S	T
U	V	W	X	Y
Z	space			

Small letters

a	b	c	d	e
f	g	h	i	j
k	l	m	n	o
p	q	r	s	t
u	v	w	x	y
z	space			

Numbers and symbols

0	1	2	3	4
5	6	7	8	9
!	"	#	\$	%
&	'	()	*
+	,	-	.	/
:	;	<	=	>
?	@	_	`	space

Handling CDs

This unit has been designed to reproduce the CDs bearing the following marks.

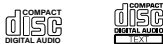

You can also play back your original CD-Rs (Recordable) and CD-RWs (Rewritable) on this receiver.

This unit is not compatible with MP3.

How to handle CDs

When removing a CD from its case, press down the center holder of the case and lift the

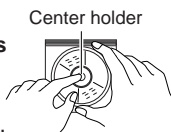

CD out, holding it by the edges.

- Always hold the CD by the edges. Do not touch its recording surface.

When storing a CD into its case, gently insert the CD around the center holder (with the printed surface facing up).

- Make sure to store CDs into the cases after use.

To keep CDs clean

A dirty CD may not play correctly. If a CD does become dirty, wipe it with a soft cloth in a straight line from center to edge.



To play new CDs

New CDs may have some rough spots around the inner and outer edges. If such a CD is used, this unit may reject the CD.



To remove these rough spots, rub the edges with a pencil or ball-point pen, etc.

Moisture condensation

Moisture may condense on the lens inside the CD player in the following cases:

- After starting the heater in the car.
- If it becomes very humid inside the car.

Should this occur, the CD player may malfunction. In this case, eject the CD and leave the unit turned on for a few hours until the moisture evaporates.

CAUTIONS:

- Do not insert 8cm (3 3/16") CDs (single CDs) into the loading slot. (Such CDs cannot be ejected.)
- Do not insert any CD of unusual shape — like a heart or flower; otherwise, it will cause a malfunction.
- Do not expose CDs to direct sunlight or any heat source or place them in a place subject to high temperature and humidity. Do not leave them in a car.
- Do not use any solvent (for example, conventional record cleaner, spray, thinner, benzine, etc.) to clean CDs.

When playing a CD-R or CD-RW

User-edited CD-Rs (Recordable) and CD-RWs (Rewritable) can be played back only if they are already "finalized."

- You can play back your original CD-Rs or CD-RWs recorded in music CD format. (However, they may not be played back depending on their characteristics or recording conditions.)
- Before playing back CD-Rs or CD-RWs, read their instructions or cautions carefully.
- Some CD-Rs or CD-RWs may not be played back on this unit because of their disc characteristics, damage or stain on them, or if the player's lens is dirty.
- CD-Rs or CD-RWs are susceptible to high temperatures or high humidity; so do not leave them inside your car.
- CD-RWs may require a longer readout time. (This is caused by the fact that the reflectance of CD-RWs is lower than for regular CDs.)

About mistracking:



Mistracking may result from driving on extremely rough roads. This does not damage the unit and the CD, but will be annoying. We recommend that you stop CD play while driving on such rough roads.



TROUBLESHOOTING

ENGLISH

What appears to be trouble is not always serious. Check the following points before calling a service center.

Symptoms	Causes	Remedies
• CD cannot be played back.	CD is inserted upside down.	Insert the CD correctly.
• CD sound is sometimes interrupted.	You are driving on rough roads.	Stop CD play while driving on rough roads.
	CD is scratched.	Change the CD.
	Connections are incorrect.	Check the cords and connections.
• Sound cannot be heard from the speakers.	The volume level is set to the minimum level.	Adjust it to the optimum level.
	Connections are incorrect.	Check the cords and connections.
• SSM (Strong-station Sequential Memory) automatic preset does not work.	Signals are too weak.	Store stations manually.
• Static noise while listening to the radio.	The antenna is not connected firmly.	Connect the antenna firmly.
• "NO DISC" appears on the display.	No CD is in the magazine.	Insert CD.
• "RESET 8" appears on the display.	This unit is not connected to a CD changer correctly.	Connect this unit and the CD changer correctly and press the reset button of the CD changer.
• "RESET 1" – "RESET 7" appears on the display.	_____	Press the reset button of the CD changer.
• "NO DISC" or "EJECT ERR" appears on the display and CD cannot be ejected.	The CD player may function incorrectly.	While pressing  , press and hold  for more than 2 seconds. (Be careful not to drop the CD when ejecting.)
• No message appears on the display but CD cannot be ejected.		
• This unit does not work at all. • The CD changer does not work at all.	The built-in microcomputer may function incorrectly due to noise, etc.	Press the reset button on the control panel. (See page 2.)

AUDIO AMPLIFIER SECTION

Maximum Power Output:

Front: 50 W per channel

Rear: 50 W per channel

Continuous Power Output (RMS):

Front: 19 W per channel into 4 Ω , 40 Hz to 20 000 Hz at no more than 0.8% total harmonic distortion.

Rear: 19 W per channel into 4 Ω , 40 Hz to 20 000 Hz at no more than 0.8% total harmonic distortion.

Load Impedance: 4 Ω (4 Ω to 8 Ω allowance)

Equalizer Control Range:

LOW: ± 12 dB (50 Hz, 80 Hz, 120 Hz)

MID: ± 12 dB (700 Hz, 1 kHz, 2 kHz)

HIGH: ± 12 dB (8 kHz, 12 kHz)

Frequency Response: 40 Hz to 20 000 Hz

Signal-to-Noise Ratio: 70 dB

Line-In Level/Impedance:

KD-SH77R : 1.5 V/20 k Ω load

Line-Out Level/Impedance:

KD-SH55R : 2.0 V/20 k Ω load (full scale)

KD-SH77R : 4.0 V/20 k Ω load (full scale)

Output Impedance: 1 k Ω

auxiliary input jack : (3.5 mm dia. stereo mini jack)

TUNER SECTION

Frequency Range:

FM: 87.5 MHz to 108.0 MHz

AM: (MW) 522 kHz to 1 620 kHz

(LW) 144 kHz to 279 kHz

[FM Tuner]

Usable Sensitivity: 11.3 dBf (1.0 μ V/75 Ω)

50 dB Quieting Sensitivity:

16.3 dBf (1.8 μ V/75 Ω)

Alternate Channel Selectivity (400 kHz):

65 dB

Frequency Response: 40 Hz to 15 000 Hz

Stereo Separation: 30 dB

Capture Ratio: 1.5 dB

[MW Tuner]

Sensitivity: 20 μ V

Selectivity: 35 dB

[LW Tuner]

Sensitivity: 50 μ V

CD PLAYER SECTION

Type: Compact disc player

Signal Detection System: Non-contact optical pickup (semiconductor laser)

Number of channels: 2 channels (stereo)

Frequency Response: 5 Hz to 20 000 Hz

Dynamic Range: 98 dB

Signal-to-Noise Ratio: 102 dB

Wow and Flutter: Less than measurable limit

GENERAL

Power Requirement:

Operating Voltage: DC 14.4 V

(11 V to 16 V allowance)

Grounding System: Negative ground

Allowable Operating Temperature: 0°C to +40°C

Dimensions (W \times H \times D):

Installation Size: 182 mm \times 52 mm \times 161 mm

Panel Size: 188 mm \times 58 mm \times 17 mm

Mass: 1.8 kg (excluding accessories)

Design and specifications subject to change without notice.

Having TROUBLE with operation?

Please reset your unit

Refer to page of How to reset your unit

Haben Sie PROBLEME mit dem Betrieb?

Bitte setzen Sie Ihr Gerät zurück

Siehe Seite Zurücksetzen des Geräts

Vous avez des PROBLÈMES de fonctionnement?

Réinitialisez votre appareil

Référez-vous à la page intitulée Comment réinitialiser votre appareil

Hebt u PROBLEMEN met de bediening?

Stel het apparaat terug

Zie de pagina met de paragraaf Het apparaat terugstellen

JVC

VICTOR COMPANY OF JAPAN, LIMITED



EN, GE, FR, NL



0201MNMDWJES

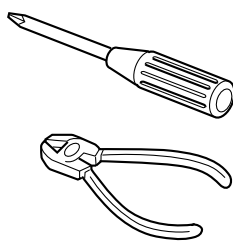

ENGLISH

- This unit is designed to operate on 12 V DC, NEGATIVE ground electrical systems.

INSTALLATION (IN-DASH MOUNTING)

- The following illustration shows a typical installation. However, you should make adjustments corresponding to your specific car. If you have any questions or require information regarding installation kits, consult your JVC IN-CAR ENTERTAINMENT dealer or a company supplying kits.

DEUTSCH

- Dieses Gerät ist für einen Betrieb in elektrischen Anlagen mit 12 V Gleichstrom und (-) Erdung ausgelegt.

EINBAU (IM ARMATURENBRETT)

- Die folgende Abbildung zeigt einen typischen Einbau. Dennoch müssen Sie entsprechend Ihrem jeweiligen Auto Anpassungen vornehmen. Bei irgendwelchen Fragen oder wenn Sie Informationen hinsichtlich des Einbausatzes brauchen, wenden Sie sich an ihren JVC Autoradiohändler oder ein Unternehmen das diese Einbausätze vertreibt.

FRANÇAIS

- Cet appareil est conçu pour fonctionner sur des sources de courant continu de 12 V à masse NEGATIVE.

INSTALLATION (MONTAGE DANS LE TABLEAU DE BORD)

- L'illustration suivante est un exemple d'installation typique. Cependant, vous devez faire les ajustements correspondant à votre voiture particulière. Si vous avez des questions ou avez besoin d'information sur des kits d'installation, consulter votre revendeur d'autoradios JVC ou une compagnie d'approvisionnement.

NEDERLANDS

- Dit apparaat mag worden gebruikt bij elektrische systemen die werken op 12 V gelijkstroom met negatieve aarding.

INSTALLATIE (INBOUW IN HET DASHBOARD)

- Op de volgende afbeelding kunt u zien hoe de installatie, normaal gesproken, in zijn werk gaat. U moet echter bij de installatie rekening houden met de bijzonderheden van uw eigen auto. Neem bij vragen of voor meer bijzonderheden over inbouwpakketten contact op met uw JVC car audio dealer of een dealer of een bedrijf dat inbouwpakketten levert.

1 Before mounting: Press (Control Panel Release button) to detach the control panel if already attached.

* When shipped from the factory, the control panel is packed in the hard case.

2 Remove the trim plate.

3 Remove the sleeve after disengaging the sleeve locks.

① Stand the unit.

Note: When you stand the unit, be careful not to damage the fuse on the rear.

② Insert the 2 handles between the unit and the sleeve, as illustrated, to disengage the sleeve locks.

③ Remove the sleeve.

Note: Be sure to keep the handles for future use after installing the unit.

4 Install the sleeve into the dashboard.

* After the sleeve is correctly installed into the dashboard, bend the appropriate tabs to hold the sleeve firmly in place, as illustrated.

5 Fix the mounting bolt to the rear of the unit's body and place the rubber cushion over the end of the bolt.

6 Do the required electrical connections.

7 Slide the unit into the sleeve until it is locked.

8 Attach the trim plate.

9 Attach the control panel.

1 Vor dem Einbau: Drücken Sie (Schalttafel-Freigabetaste), um die Arretierung der Schalttafel zu lösen, sofern diese bereits angebracht ist.

* Bei der Auslieferung ab Werk ist die Schalttafel im Etui verpackt.

2 Den Frontrahmen herausnehmen.

3 Die Halterung nach dem Entriegeln der Halterungssperren abnehmen.

① Das Gerät aufstellen.

Hinweis: Beim Aufstellen des Geräts darauf achten, daß die Sicherung auf der Rückseite nicht beschädigt wird.

② Die 2 Griffe zwischen dem Gerät und der Halterung wie abgebildet einstecken und die Halterungssperren entriegeln.

③ Die Halterung entfernen.

Hinweis: Sicherstellen, daß die Griffe für künftigen Gebrauch nach dem Einbau des Geräts aufbewahrt werden.

4 Die Halterung im Armaturenbrett einbauen.

* Nach dem korrekten Einbau der Halterung im Armaturenbrett, die entsprechenden Riegel umknicken, um die Halterung an ihrem Platz zu sichern, siehe Abbildung.

5 Die Befestigungsschraube an der Rückseite des Gerätekörpers befestigen und das Ende der Schraube mit einem Gummipuffer abdecken.

6 Nehmen Sie die erforderlichen elektrischen Anschlüsse vor.

7 Das Gerät in die Halterung schieben, bis es einrastet.

8 Befestigen Sie die Frontrahmen.

9 Die Schalttafel anbringen.

1 Avant le montage: Appuyer sur (déblocage du panneau de commande) pour éventuellement détacher le panneau de commande.

* Lorsque ce panneau de commande sort d'usine, il est rangé dans un étui de transport.

2 Retirer la plaque d'assemblage.

3 Libérer les verrous du manchon et retirer le manchon.

① Poser l'appareil à la verticale.

Remarque: Lorsque vous mettez l'appareil à la verticale, faire attention de ne pas endommager le fusible situé sur l'arrière.

② Insérer les 2 poignées entre l'appareil et le manchon comme indiqué pour désengager les verrous de manchon.

③ Retirer le manchon.

Remarque: S'assurer de garder les poignées pour une utilisation ultérieure, après l'installation de l'appareil.

4 Installer le manchon dans le tableau de bord.

* Après installation correcte du manchon dans le tableau de bord, plier les bonnes pattes pour maintenir fermement le manchon en place, comme montré.

5 Monter le boulon de montage sur l'arrière du corps de l'appareil puis passer l'amortisseur en caoutchouc sur l'extrémité du boulon.

6 Réaliser les connexions électriques.

7 Faire glisser l'appareil dans le manchon jusqu'à ce qu'il soit verrouillé.

8 Attachez la plaque d'assemblage.

9 Remonter le panneau de commande.

1 Voordat u aan de montage van het apparaat begint: Druk op (het bedieningspaneel vrijgeven) als u het bedieningspaneel wilt loskoppelen indien dit aan de eenheid is vastgekoppeld.

* Standaard wordt het bedieningspaneel bij het verlaten van de fabriek los verpakt meegeleverd.

2 Verwijder de sierplaat.

3 Verwijder het huis nadat u de klemmen hebt losgemaakt.

① Zet het apparaat rechtop.

Opmerking: Wanneer u het apparaat rechtop zet, moet u erop letten dat u de zekering aan de achterkant niet beschadigt.

② Plaats de 2 hendels, zoals afgebeeld, tussen het apparaat en het huis, om de klemmen los te maken.

③ Verwijder het huis.

Opmerking: Bewaar de hendels nadat u het apparaat hebt geïnstalleerd, zodat u ze ook in de toekomst kunt gebruiken.

4 Installeer het huis in het dashboard.

* Nadat het huis op de juiste wijze in het dashboard is geplaatst, moet u de palletjes, zoals afgebeeld, stevig op hun plaats duwen.

5 Maak de bevestigingsbout aan de achterkant van het apparaat vast en plaats de rubberdop over het uiteinde van de bout.

6 Breng de vereiste elektrische verbindingen tot stand.

7 Schuif het apparaat in het huis totdat het vergrendeld is.

8 Bevestig de sierplaat.

9 Bevestig het bedieningspaneel.

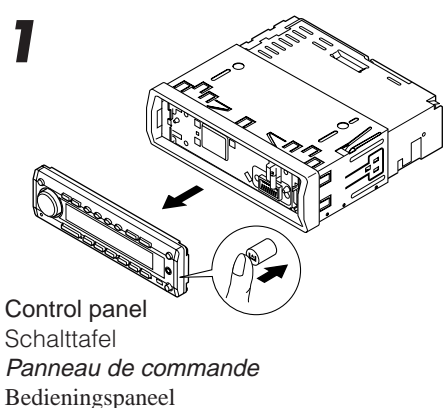

Control panel
Schalttafel
Panneau de commande
Bedieningspaneel

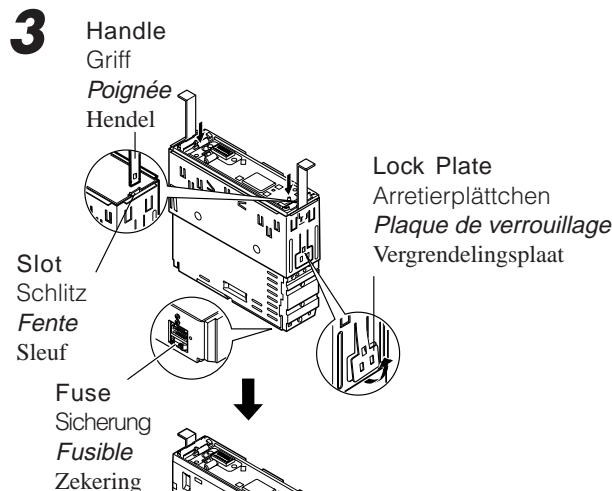

Handle
Griff
Poignée
Hendel

Lock Plate
Arretierplättchen
Plaque de verrouillage
Vergrendelingsplaat

Slot
Schlitz
Fente
Sleuf

Fuse
Sicherung
Fusible
Zekering

Sleeve
Halterung
Manchon
Huis

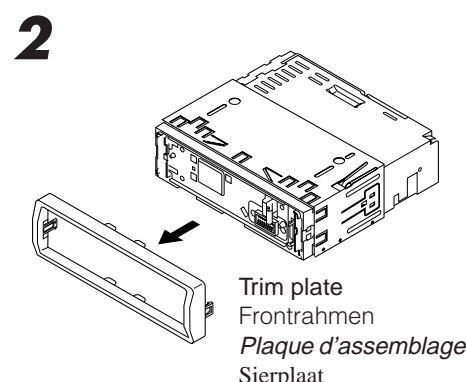

Trim plate
Frontrahmen
Plaque d'assemblage
Sierplaat

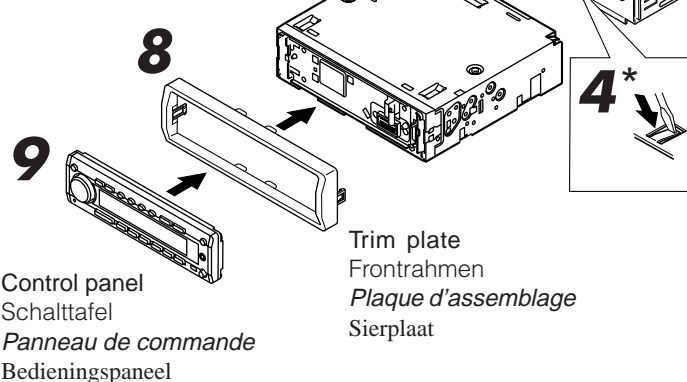

Control panel
Schalttafel
Panneau de commande
Bedieningspaneel

Rubber cushion
Gummipuffer
Amortisseur en caoutchouc
Rubberdop

Dashboard
Armaturenbrett
Tableau de bord
Dashboard

Sleeve
Halterung
Manchon
Huis

Mounting bolt
Befestigungsschraube
Boulon de montage
Bevestigingsbout

6 See "ELECTRICAL CONNECTIONS." Siehe „ELEKTRISCHE ANSCHLÜSSE“. Référez-vous "RACCORDEMENTS ELECTRIQUES". Zie "ELEKTRISCHE VERBINDINGEN".

- When using the optional stay
- Beim Verwenden der Anker-Option
- Lors de l'utilisation du hauban en option
- Wanneer u de steun gebruikt (facultatief)

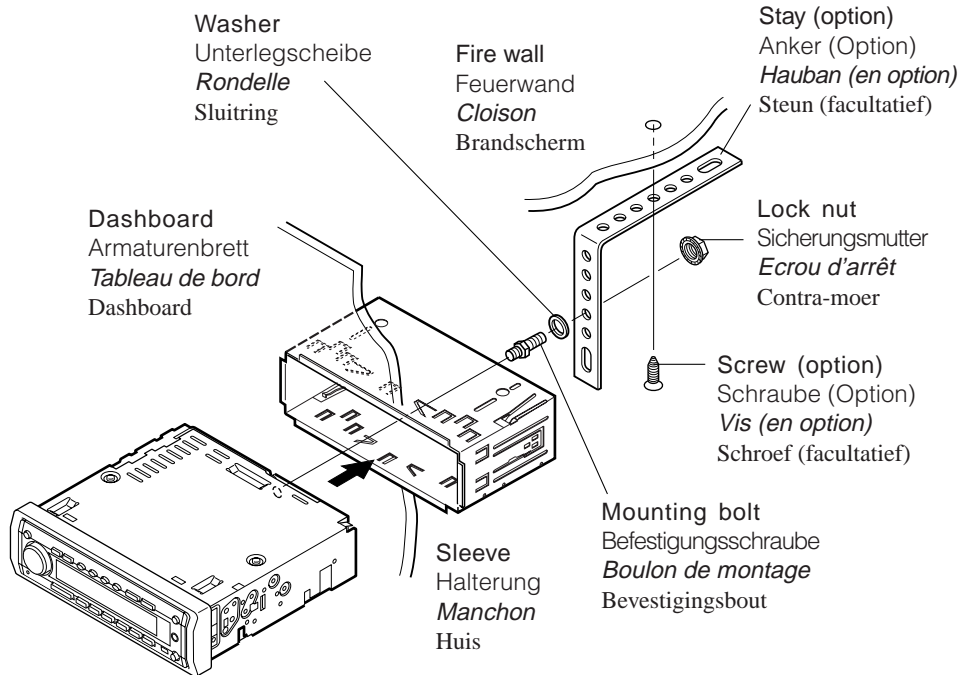

- When installing the unit without using the sleeve
- Beim Einbau des Geräts ohne Halterung
- Lors de l'installation de l'appareil sans utiliser de manchon
- Wanneer u het apparaat zonder huis installeert

In a Toyota for example, first remove the car radio and install the unit in its place.
Zum Beispiel in einem Toyota zuerst das Autoradio ausbauen und dann das Gerät an seinem Platz einbauen.
Par exemple dans une Toyota, retirer d'abord l'autoradio et installer l'appareil à la place.
Voorbeeld: Bij een Toyota moet u eerst de autoradio verwijderen en daarna het apparaat installeren.

Flat type screws (M5 x 6 mm)*
Senkkopfschrauben (M5 x 6 mm)*
Vis à tête plate (M5 x 6 mm)*
Platkopfschroeven (M5 x 6 mm)*

Bracket*
Konsole*
Support*
Console*

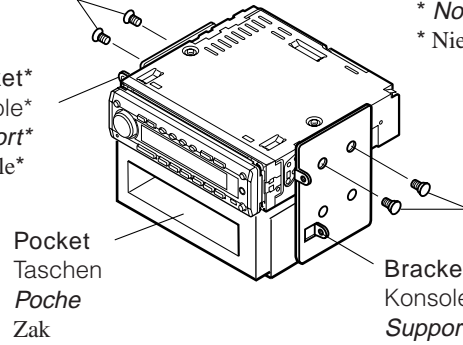

* Not included with this unit.
* Nicht Teil dieses Geräts.
* Non fourni avec cet appareil.
* Niet meegeleverd.

Flat type screws (M5 x 6 mm)*
Senkkopfschrauben (M5 x 6 mm)*
Vis à tête plate (M5 x 6 mm)*
Platkopfschroeven (M5 x 6 mm)*

Note: When installing the unit on the mounting brackets, make sure to use the 6 mm-long screws. If longer screws are used, they could damage the unit.

Hinweis: Beim Anbringen des Geräts an der Konsole sicherstellen, daß 6 mm lange Schrauben verwendet werden. Werden längere Schrauben verwendet, können sie das Gerät beschädigen.

Remarque: Lors de l'installation de l'appareil sur le support de montage, s'assurer d'utiliser des vis d'une longueur de 6 mm.

Si des vis plus longues sont utilisées, elles peuvent endommager l'appareil.

Opmerking: Wanneer u het apparaat aan de bevestigingsklem vastmaakt, moet u de 6 mm lange schroeven gebruiken. Als u langere schroeven gebruikt, kan het apparaat worden beschadigd.

Removing the unit

- Before removing the unit, release the rear section.
- 1** Remove the control panel.
- 2** Remove the trim plate.
- 3** Insert the 2 handles into the slots, as shown. Then, while gently pulling the handles away from each other, slide out the unit. **(Be sure to keep the handles after installing it.)**

Ausbau des Geräts

- Vor dem Ausbau des Geräts den hinteren Teil freigeben.
- 1** Den Schalttafel abnehmen.
- 2** Den Frontrahmen herausnehmen.
- 3** Die 2 Griffe in die Schlitzte wie gezeigt stecken. Dann die Griffe behutsam auseinander ziehen und das Gerät herausziehen. **(Die Griffe nach dem Einbau auf jeden Fall aufbewahren.)**

Retrait de l'appareil

- Avant de retirer l'appareil, libérer la section arrière.
- 1** Retirer le panneau de commande.
- 2** Retirer la plaque d'assemblage.
- 3** Introduire les 2 poignées dans les fentes, comme montré. Puis, tout en tirant doucement les poignées écartées, faire glisser l'appareil pour le sortir. **(S'assurer de conserver les poignées après l'installation de l'appareil.)**

Verwijderen van het apparaat

- Voordat u het apparaat verwijdert, moet u het achtergedeelte losmaken.
- 1** Verwijder het bedieningspaneel.
- 2** Verwijder de sierplaat.
- 3** Plaats de 2 hendels, zoals afgebeeld, in de sleuven. Daarna duwt u de hendels zachtjes uit elkaar en kunt u het apparaat naar buiten schuiven. **(Bewaar de hendels nadat u het apparaat hebt geïnstalleerd!)**

1

Control panel
Schalttafel
Panneau de commande
Bedieningspaneel

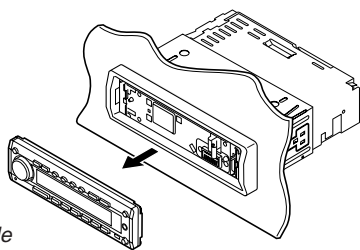

2

Trim plate
Frontrahmen
Plaque d'assemblage
Sierplaat

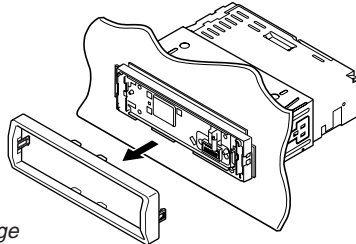

3

Handle
Griff
Poignée
Hendel

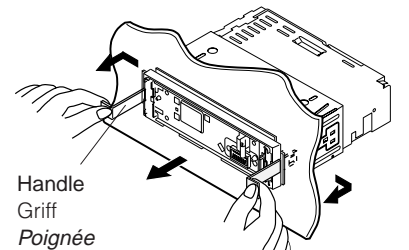

Parts list for installation and connection

The following parts are provided for this unit. After checking them, please set them correctly.

Teiliste für den Einbau und Anschluß

Die folgenden Teile werden zusammen mit diesem Gerät geliefert. Nach ihrer Überprüfung, die Teile richtig einsetzen.

Liste des pièces pour l'installation et raccordement

Les pièces suivantes sont fournies avec cet appareil. Après vérification, veuillez les placer correctement.

Lijst van onderdelen die u bij installatie en aansluiting nodig hebt

De volgende onderdelen worden bij het apparaat geleverd. Installeer ze op de juiste wijze, nadat u ze hebt gecontroleerd.

Hard case/Control panel
Etui/Schalttafel
Etui de transport/Panneau de commande
Behuizing/Bedieningspaneel

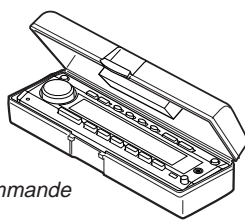

Sleeve
Halterung
Manchon
Huis

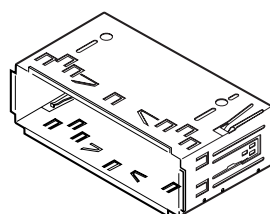

Trim plate
Frontrahmen
Plaque d'assemblage
Sierplaat

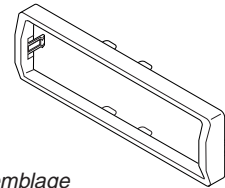

Remote controller
Fernbedienung
Télécommande
Afstandsbediening



Battery
Batterie
Pile
Batterij



Power cord
Stromkabel
Cordon d'alimentation
Stroomkabel

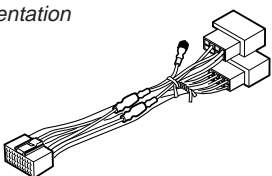

Handles
Griffe
Poignées
Hendels



Washer (ø5)
Unterlegscheibe(ø5)
Rondelle (ø5)
Sluitring (ø5)



Lock nut (M5)
Sicherungsmutter (M5)
Ecrou d'arrêt (M5)
Contra-moer (M5)



Mounting bolt (M5 x 20 mm)
Befestigungsschraube (M5 x 20 mm)
Boulon de montage (M5 x 20 mm)
Bevestigingsbout (M5 x 20 mm)



Rubber cushion
Gummipuffer
Amortisseur en caoutchouc
Rubberdop



ELECTRICAL CONNECTIONS ELEKTRISCHE ANSCHLÜSSE RACCORDEMENTS ELECTRIQUES ELEKTRISCHE VERBINDINGEN

To prevent short circuits, we recommend that you disconnect the battery's negative terminal and make all electrical connections before installing the unit. If you are not sure how to install this unit correctly, have it installed by a qualified technician.

Zur Vermeidung von Kurzschlüssen empfehlen wir, daß Sie den negativen Batterieanschluß abtrennen und alle elektrischen Anschlüsse herstellen, bevor das Gerät eingebaut wird. Sind Sie sich über den richtigen Einbau des Geräts nicht sicher, lassen Sie es von einem qualifizierten Techniker einbauen.

Pour éviter tout court-circuit, nous vous recommandons de débrancher la borne négative de la batterie et d'effectuer tous les raccordements électriques avant d'installer l'appareil. Si l'on n'est pas sûr de pouvoir installer correctement cet appareil, le faire installer par un technicien qualifié.

Om kortsluiting te voorkomen adviseren wij u om de minpool van de accu los te maken en alle elektrische verbindingen tot stand te brengen voordat u het apparaat in de auto installeert. Als u niet zeker weet hoe u dit apparaat moet installeren, kunt u dit beter door een daartoe gekwalificeerde technicus laten doen.

Note:

This unit is designed to operate on **12 V DC, NEGATIVE ground electrical systems**. If your vehicle does not have this system, a voltage inverter is required, which can be purchased at JVC IN-CAR ENTERTAINMENT dealers.

- Replace the fuse with one of the specified rating. If the fuse blows frequently, consult your JVC IN-CAR ENTERTAINMENT dealer.
- If noise is a problem...

This unit incorporates a noise filter in the power circuit. However, with some vehicles, clicking or other unwanted noise may occur. If this happens, connect the unit's **rear ground terminal** (see connection diagram) to the car's chassis using shorter and thicker cords, such as copper braiding or gauge wire. If noise still persists, consult your JVC IN-CAR ENTERTAINMENT dealer.

- Maximum input of the speakers should be no more than 50 W at the rear and 50 W at the front, with an impedance of **4 Ω to 8 Ω**.
- **Be sure to ground this unit to the car's chassis.**
- The heat sink becomes very hot after use. Be careful not to touch it when removing this unit.

Hinweis:

Dieses Gerät ist für einen Betrieb in **elektrischen Anlagen mit 12 V Gleichstrom und (-) Erdung** ausgelegt. Verfügt Ihr Fahrzeug nicht über diese Anlage, ist ein Spannungsinverter erforderlich, der bei JVC Autoradiohändler erworben werden kann.

- Die Sicherung mit einer der entsprechenden Nennleistung ersetzen. Brennt die Sicherung häufig durch, wenden Sie sich an ihren JVC Autoradiohändler.
- Sind Störgeräusche ein Problem...

Dieses Gerät enthält ein Störfilter im Stromkreis. Bei manchen Fahrzeugen kann jedoch ein Klicken oder andere unerwünschte Störgeräusche auftreten. Sollte das der Fall sein, die **hintere Erdungscanschlußklemme** (siehe Schaltplan) des Geräts am Fahrwerk des Fahrzeugs anschließen, dabei kürzere und dickere Kabel wie beispielsweise Kupfergeflecht draht oder Stahldraht verwenden. Bleibt Störgeräusch bestehen, wenden Sie sich an Ihren JVC Autoradiohändler.

- Maximale Eingangsleistung der Lautsprecher sollte nicht mehr als 50 W hinten und 50 W vorne sein, mit einer Impedanz von **4 Ω bis 8 Ω**.
- **Sicherstellen, daß das Gerät am Fahrwerk geerdet wird.**

- Das Abstrahlblech wird nach dem Gebrauch sehr heiß. Beim Ausbau des Geräts darauf achten, das Abstrahlblech nicht zu berühren.

Remarque:

Cet appareil est conçu pour fonctionner sur des sources de courant continu de **12 V à masse NEGATIVE**. Si votre véhicule n'offre pas ce type d'alimentation, il vous faut un convertisseur de tension, que vous pouvez acheter chez un revendeur d'autoradios JVC.

- Remplacer le fusible par un de la valeur précisée. Si le fusible saute souvent, consulter votre revendeur d'autoradios JVC.
- Si le bruit est un problème...

Cet appareil incorpore un filtre de bruit dans le circuit d'alimentation. Cependant, avec certains véhicules, quelques claquements ou autres bruits non désirés risquent de se produire. Si cela arrive, raccorder la borne arrière de masse de l'appareil au châssis de la voiture (voir le diagramme de raccordement) en utilisant des cordons les plus gros et les plus courts possibles telle qu'une barre de cuivre ou une tresse. Si le bruit persiste, consulter votre revendeur d'autoradios JVC.

- La puissance admissible des enceintes devrait n'être pas plus qu'c 50 W à l'arrière et à 50 W a l'avant, avec une impédance de **4 Ω à 8 Ω**.
- **S'assurer de raccorder la mise à la masse de cet appareil au châssis de la voiture.**

- Le dissipateur de chaleur devient très chaud après usage. Faire attention de ne pas le toucher en retirant cet appareil.

Opmerking:

Dit apparaat mag worden gebruikt bij elektrische systemen die werken op **12 V gelijkstroom met negatieve aarding**. Als uw auto niet is uitgerust met een dergelijk systeem, is een spanningsomzetter vereist. Dit instrument kan worden aangeschaft bij JVC car audio dealers.

- Vervang de zekering door een exemplaar met het aangegeven vermogen. Als de zekering vaak doorslaat, moet u uw JVC car audio dealer raadplegen.
- Als u geluidsproblemen hebt...

De krachtschakeling van dit apparaat heeft een ingebouwd geluidsfilter. In sommige voertuigen zijn tikgeluiden of andere ongewenste geluiden te horen. Als dit gebeurt, moet u de **massaklem aan de achterkant** (zie aansluitingsschema) aan het chassis van de auto vastmaken met behulp van een kortere en dikkere kabel, zoals kopermanteldraad of tellerkabel. Als het geluid niet verdwijnt, moet u contact opnemen met uw JVC car audio dealer.

- Het maximum ingangsvermogen van de speakers moet achterin niet meer dan 50 W zijn en voorin 50 W, met een impedantie van **4 Ω tot 8 Ω**.
- **Zorg ervoor dat dit apparaat door middel van een aardkabel is verbonden met het chassis van de auto.**

- De warmte-opnemer kan na gebruik erg heet worden. Raak de warmte-opnemer niet aan wanneer u dit apparaat van zijn plaats haalt.

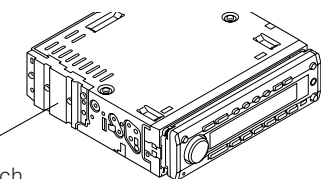

Heat sink
Abstrahlblech
Dissipateur de chaleur
Warmte-opnemer

Connecting the leads / Anschließen der Leitungen / Raccordement des fils / Aansluiting van de gekleurde draden

Twist the core wires when connecting.
Die Kerndrähte beim Anschließen verdrehen.
Torsader les âmes des fils en les raccordant.
Draai de kerndraden om elkaar heen wanneer u ze wilt aansluiten.

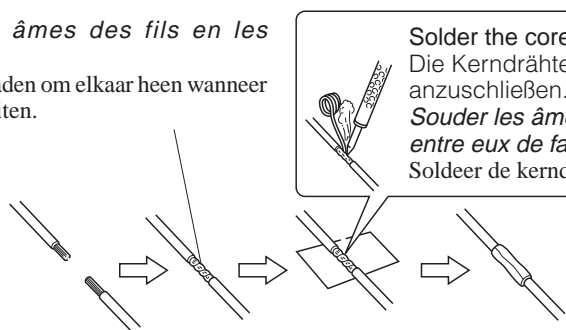

Solder the core wires to connect them securely.
Die Kerndrähte anlöten, um sie fest anzuschließen.
Souder les âmes des fils pour les raccorder entre eux de façon sûre.
Soldeer de kerndraden zodat ze stevig vast zitten.

CAUTION / VORSICHT / PRECAUTION / LET OP!:

- To prevent short-circuit, cover the terminals of the **UNUSED** leads with insulating tape.
- Zur Vermeidung eines Kurzschlusses die Anschlußklemmen der **NICHT VERWENDETEN** Leitungen mit Isolierklebeband umwickeln.
- Pour éviter les court-circuits, couvrir les bornes des fils qui ne sont **PAS** utilisés avec de la bande isolante.
- Om kortsluiting te voorkomen, moet u de aansluitklemmen van **ONGEBRUIKTE** gekleurde draden met isolatieband bedekken.

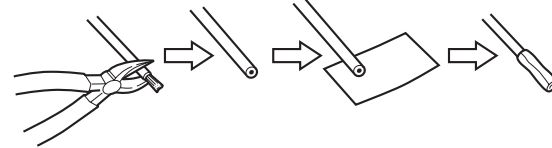

A If your car is equipped with the ISO connector Wenn Ihr Auto mit ISO-Steckern ausgestattet ist Si votre voiture est équipée d'un connecteur ISO Indien uw auto is uitgerust met de ISO-connector

- Connect the ISO connectors as illustrated.
- Die ISO-Stecker wie abgebildet anschließen.
- Connectez les connecteurs ISO comme montré sur l'illustration.
- Sluit de ISO-connectoren aan zoals op het voorbeeld is aangegeven.

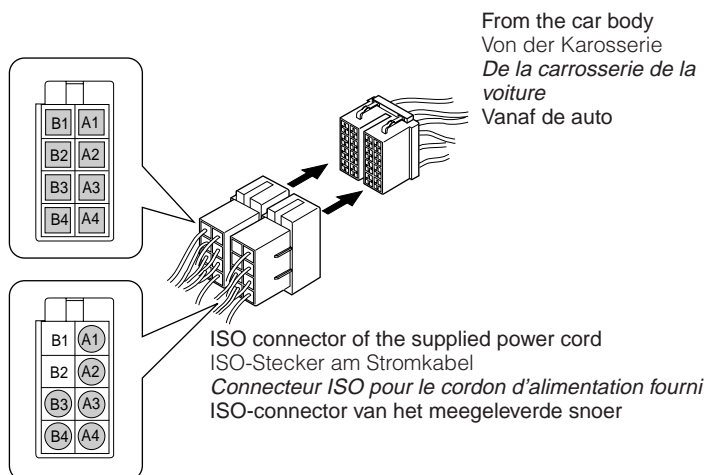

From the car body
Von der Karosserie
De la carrosserie de la voiture
Vanaf de auto

ISO connector of the supplied power cord
ISO-Stecker am Stromkabel
Connecteur ISO pour le cordon d'alimentation fourni
ISO-connector van het meegeleverde snoer

View from the lead side
Ansicht von der Leitungsseite
Vue à partir du côté des fils
Aanzicht vanaf het snoer

For some VW/Audi or Opel (Vauxhall) automobile Für manche VW/Audi oder Opel (Vauxhall) Fahrzeuge Pour certaine voiture VW/Audi ou Opel (Vauxhall) Voor bepaalde modellen VW/Audi of Opel (Vauxhall) geldt

You may need to modify the wiring of the supplied power cord as illustrated.

- Contact your authorized car dealer before installing this unit.
- Sie müssen evtl. die Verdrahtung des mitgelieferten Stromkabels wie abgebildet ändern.
- Wenden Sie sich an Ihre Vertragswerkstatt, bevor Sie das Gerät einbauen.
- Vous aurez peut-être besoin de modifier le câblage du cordon d'alimentation fourni comme montré sur l'illustration.
- Contactez votre revendeur automobile autorisé avant d'installer l'appareil.
- Wellicht moet u de bedrading van het meegeleverde snoer als in het voorbeeld aanpassen.
- Neem contact op met uw officiële autodealer alvorens dit apparaat te installeren.

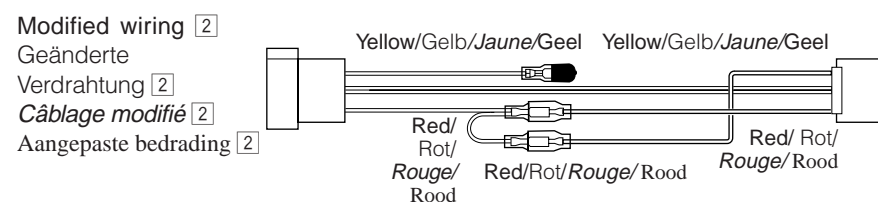
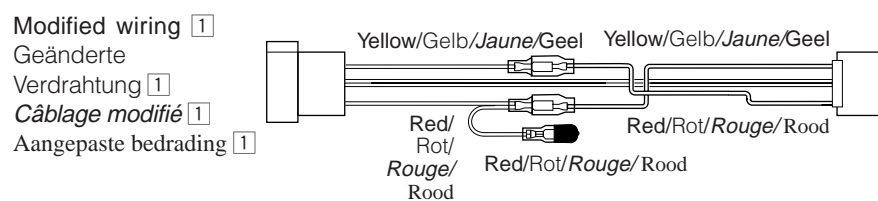
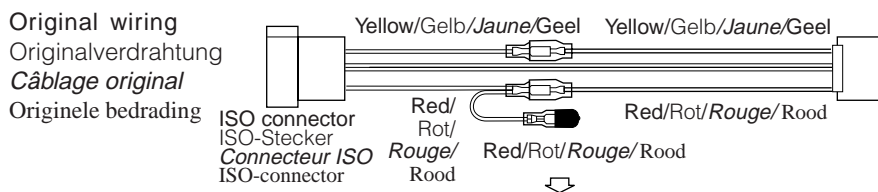

Use modified wiring [2] if the unit does not turn on.
Geänderte Verdrahtung [2] verwenden, wenn das Gerät so nicht an geht.
Utilisez le câblage modifié [2] si l'appareil ne se met pas sous tension.
Pas de bedrading [2] aan indien het apparaat niet reageert bij inschakelen.

B Connections without using the ISO connectors / Anschlüsse ohne ISO-Stecker / Connexions sans l'utilisation des connecteurs ISO / Verbindungen zonder ISO-connectoren

Before connecting: Check the wiring in the vehicle carefully. Incorrect connection may cause serious damage to this unit.

- 1 Cut the ISO connector.
- 2 Connect the colored leads of the power cord to the car battery, speakers and power aerial (if any) in the following sequence.
 - 1 Black: ground
 - 2 Yellow: to car battery (constant 12 V)
 - 3 Red: to an accessory terminal
 - 4 Blue with white stripe: to power aerial (200 mA max.)
 - 5 Orange with white stripe: to car light control switch
 - 6 Brown: to cellular phone system (For details, refer to the instructions of the cellular phone.)
 - 7 Others: to speakers
- 3 Connect the aerial cord.
- 4 Finally connect the wiring harness to the unit.

Vor dem Anschließen: Die Verdrahtung im Fahrzeug sorgfältig überprüfen. Falsche Anschlüsse können ernsthafte Schäden am Gerät hervorrufen.

- 1 Den ISO-Stecker abschneiden.
- 2 Die farbigen Leitungen des Spannungsversorgungskabels an der Autobatterie, den Lautsprechern und dem Motorantenne (sofern vorhanden) in folgender Reihenfolge anschließen.
 - 1 Schwarz: Erdung
 - 2 Gelb: an Autobatterie (konstant 12 V)
 - 3 Rot: zur einer Zubehöransteckleuchte
 - 4 Blau mit weißem Streifen: zur Motorantenne (max. 200 mA)
 - 5 Orange mit weißem Streifen: zur Autolichtschalter
 - 6 Braun: zur Mobiltelefon (Weitere Informationen entnehmen Sie bitte der Bedienungsanleitung des Mobiltelefons.)
 - 7 Andere: zur Lautsprecher
- 3 Das Antennenkabel anschließen.
- 4 Die Kabelbäume am Gerät anschließen.

Avant de commencer la connexion: vérifiez attentivement le câblage du véhicule. Une connexion incorrecte peut endommager sérieusement l'appareil.

- 1 Coupez le connecteur ISO.
- 2 Connectez les fils de couleur du cordon d'alimentation à la batterie de la voiture, aux enceintes et à l'antenne automatique (s'il y en a une) dans l'ordre suivant.
 - 1 Noir: à la masse
 - 2 Jaune: à la batterie de la voiture (12 V constant)
 - 3 Rouge: à la prise accessoire
 - 4 Bleu avec bande blanche: à l'antenne automatique (200 mA max.)
 - 5 Orange avec bande blanche: à l'interrupteur d'éclairage de la voiture
 - 6 Marron: à un système de téléphone cellulaire (Pour les détails, se référer aux instructions du téléphone cellulaire.)
 - 7 Autres: aux enceintes
- 3 Connectez le cordon d'antenne.
- 4 Finalement, connectez le faisceau de fils à l'appareil.

Alvorens de verbindingen tot stand te brengen: moet u de bedrading in de auto zorgvuldig. Het apparaat kan door verkeerde verbindingen ernstige schade oplopen.

- 1 Knip de ISO-connector los.
- 2 Sluit de gekleurde snoerdraden van de stroomkabel in de hierna genoemde volgorde aan op de accu van de auto, de luidsprekers en de antenne (indien aanwezig).
 - 1 Zwart: aarde
 - 2 Geel: naar de accu van de auto (constant 12 V)
 - 3 Rood: naar de aansluitklem van de accessoire
 - 4 Blauw met witte streep: naar de antenne (Max. 200 mA)
 - 5 Oranje met witte streep: naar de schakelaar voor de autoverlichting
 - 6 Bruin: naar het mobiele-telefoonsysteem (Lees voor meer informatie de instructies die bij de mobiele telefoon worden geleverd.)
 - 7 Andere: naar de speakers
- 3 Sluit de antenne aan.
- 4 Verbind de draadbundel daarna met het apparaat.

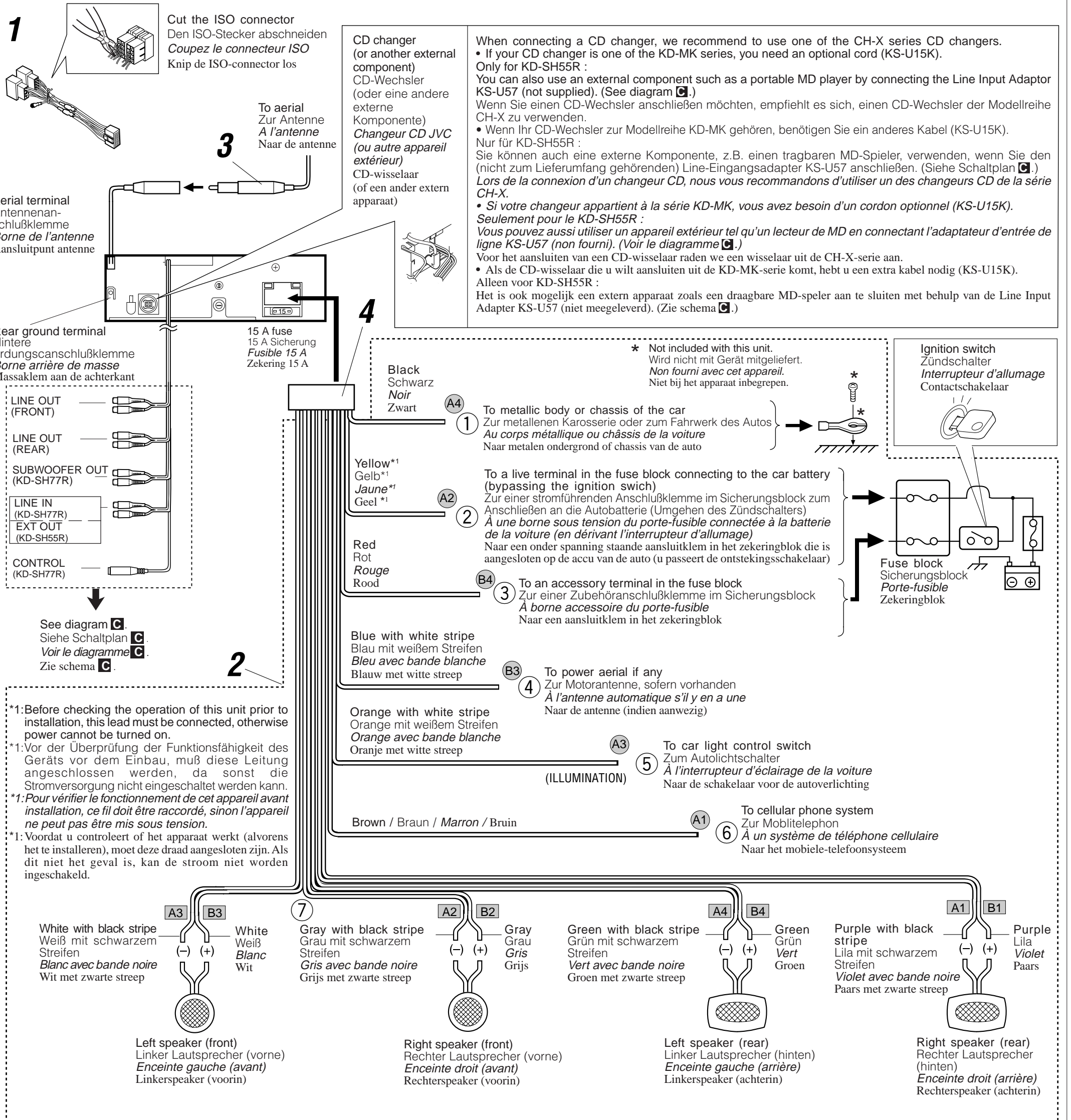

PRECAUTIONS on power supply and speaker connections:

- **DO NOT** connect the speaker leads of the power cord to the car battery; otherwise, the unit will be seriously damaged.
- Connect the black lead (ground), yellow lead (to car battery, constant 12 V), and red lead (to an accessory terminal) correctly.
- **BEFORE** connecting the speaker leads of the power cord to the speakers, check the speaker wiring in your car.
 - If the speaker wiring in your car is as illustrated in Fig. 1 and Fig. 2 below, **DO NOT** connect the unit using that original speaker wiring. If you do, the unit will be seriously damaged. Redo the speaker wiring so that you can connect the unit to the speakers as illustrated in Fig. 3.
 - If the speaker wiring in your car is as illustrated in Fig. 3, you can connect the unit using the original speaker wiring in your car.
 - If you are not sure of the speaker wiring of your car, consult your JVC IN-CAR ENTERTAINMENT dealer.

VORSICHTSMASSREGELN beim Anschließen der Stromversorgung und Lautsprecher:

- Die Lautsprecherleitungen des Netzkabels **NICHT** an der Autobatterie anschließen, da sonst das Gerät schwer beschädigt wird.
- Die schwarze Leitung (Erdung), die gelbe Leitung (zur Autobatterie, konstant 12 V) und die rote Leitung (zur Zubehöranschlusßklemme) richtig anschließen.
- **VOR** dem Anschließen der Lautsprecherleitungen des Spannungsversorgungskabels an die Lautsprecher, die Lautsprecherverdrahtung in Ihrem Auto überprüfen.
 - Ist die Lautsprecherverdrahtung wie unten in "Fig. 1" und "Fig. 2" abgebildet, das Gerät **NICHT** mit der Originalverdrahtung der Lautsprecher anschließen, da sonst das Gerät schwer beschädigt wird. Die Lautsprecherverdrahtung erneuern, so daß Sie das Gerät an den Lautsprechern wie in "Fig. 3" abgebildet anschließen können.
 - Ist die Lautsprecherverdrahtung in Ihrem Auto wie in "Fig. 3" abgebildet, können Sie das Gerät mit der Originalverdrahtung der Lautsprecher in Ihrem Auto anschließen.
 - Sind Sie sich über die Lautsprecherverdrahtung in Ihrem Auto nicht sicher, wenden Sie sich an Ihren Autohändler.

PRECAUTIONS sur l'alimentation et la connexion des enceintes:

- **NE CONNECTEZ PAS** les fils d'enceintes du cordon d'alimentation à la batterie; sinon, l'appareil serait sérieusement endommagé.
- Connectez correctement le fil noir (à la masse), le fil jaune (à la batterie de la voiture, 12 V constant) et le fil rouge (à la prise accessoire).
- **AVANT** de connecter les fils d'enceintes du cordon d'alimentation aux enceintes, vérifiez le câblage des enceintes de votre voiture.
 - Si le câblage des enceintes de votre voiture est comme montré sur la Fig. 1 ou Fig. 2 ci-dessous, **NE CONNECTEZ PAS** l'appareil en utilisant ce câblage original des enceintes. Si vous le faites, l'appareil sera sérieusement endommagé. Recommencez le câblage des enceintes de façon que vous puissiez connecter l'appareil aux enceintes comme montré sur la Fig. 3.
 - Si le câblage des enceintes de votre voiture est comme montré sur la Fig. 3, vous pouvez connecter l'appareil en utilisant ce câblage original d'enceintes pour votre voiture.
 - Si vous n'êtes pas sûrs du câblage d'enceintes de votre voiture, consultez le concessionnaire de votre voiture.

VOORZORGSMAATREGELEN bij het verbinden van de stroomkabeldraad met de speakers:

- Verbind de speakerdraden van de stroomkabel **NIET** met de accu van de auto; als u dit wel doet, zal het apparaat ernstige schade oplopen.
- Sluit de zwarte draad (aarde), de gele draad (naar de accu van de auto, constant 12 V) en de rode draad (naar de aansluitklem van de accessoire) op de juiste wijze aan.
- **VOORDAT** u de speakerdraden van de stroomkabel met de speakers verbindt, moet u de bedrading van de speakers in uw auto controleren.
 - Als de bedrading van de speakers eruitziet zoals hieronder staat afgebeeld in Fig. 1 en Fig. 2, mag het apparaat **NIET** worden aangesloten met behulp van deze oorspronkelijke speakerbedrading. Als u dat wel doet, zal het apparaat ernstige schade oplopen. Pas de bedrading van de speakers aan, zodat u het apparaat met de speakers kunt verbinden, zoals staat afgebeeld in Fig. 3.
 - Als de bedrading van de speakers eruitziet zoals staat afgebeeld in Fig. 3, kunt u het apparaat aansluiten met behulp van de oorspronkelijke speakerbedrading in uw auto.
 - Als u twijfels hebt over de speakerbedrading in uw auto, moet u contact opnemen met uw autodealer.

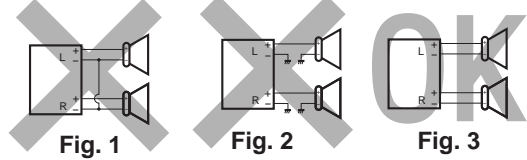

Connections Adding Other Equipment / Anschlüsse zum Hinzufügen von anderer Ausrüstung / Raccordement pour ajouter d'autres appareils / Aansluitingen voor het toevoegen van andere apparatuur

Amplifier / Verstärker / Amplificateur / Versterker

You can connect an amplifier and other equipment to upgrade your car stereo system.

- Connect the remote lead (blue with white stripe) to the remote lead of the other equipment so that it can be controlled through this unit.

For KD-SH77R:

- For amplifier:
 - Connect this unit's line-out terminals to the amplifier's line-in terminals.
 - **Disconnect the speakers from this unit, connect them to the amplifier. Leave the speaker leads of this unit unused.**
 - You can switch off the built-in amplifier and send the audio signals only to the external amplifier(s) to get clear sounds and to prevent internal heat buildup inside the unit. See page 25 of the Instructions (separate volume).
 - The line output level of this unit is kept high to maintain the hi-fi sounds reproduced from this unit.
- **When connecting an external amplifier to this unit**, turn down the gain control on the external amplifier to obtain the best performance from this unit.

Sie können einen Verstärker oder ein anderes Gerät anschließen, um Ihre Autostereoanlage zu erweitern.

- Schließen Sie das Fernbedienungskabel (blau mit weißem Streifen) an das Fernbedienungskabel des anderen Geräts an, so daß es über dieses Gerät gesteuert werden kann.

Für KD-SH77R:

- Hinweise zum Verstärker:
 - Die Anschlußklemmen am Ausgang dieses Gerät an den Anschlußklemmen des Eingangs des Verstärkers anschließen.
 - **Die Lautsprecher von diesem Gerät abtrennen und am Verstärker anschließen. Die Lautsprecherleitungen dieses Geräts unbenutzt lassen.**
 - Sie können den integrierten Verstärker ausschalten und die Audiosignale nur an den (die) externen Verstärker leiten, um einen verzerrungsfreien Klang zu erhalten und um zu verhindern, daß sich im Innern des Geräts ein Wärmestau bildet. Auf Seite 25 finden Sie weitere Anleitungen (separate Lautstärke).
 - Der Ausgangspegel dieses Geräts wird auf einem hohen Wert gehalten, um den HiFi-Klang zu unterstützen, den dieses Gerät reproduziert.
- **Wenn Sie einen externen Verstärker an dieses Gerät anschließen**, stellen Sie den Verstärkungsregler des externen Verstärkers herunter, um die bestmögliche Leistung dieses Geräts zu erzielen.

Vous pouvez connecter un amplificateur ou autre appareil pour améliorer votre système autoradio.

- Connectez le fil de commande à distance (bleu avec bande blanche) au fil de commande à distance de l'autre appareil de façon qu'il puisse être commandé via cet appareil.

Pour le KD-SH77R:

- Pour l'amplificateur seulement:
 - Raccorder les bornes de sortie ligne de cet appareil aux bornes d'entrée ligne de l'amplificateur.
 - **Déconnectez les enceintes de cet appareil et connectez-les à l'amplificateur. Laissez les fils d'enceintes de cet appareil inutilisés.**
 - Vous pouvez désactiver l'amplificateur intégré et envoyer les signaux audio uniquement à un ou plusieurs amplificateurs extérieurs afin d'obtenir un son clair et pour éviter un échauffement interne de l'appareil. Référez-vous à la page 25 du mode d'emploi (volume séparé).
 - Le niveau de sortie de ligne de cet appareil est maintenu à un niveau élevé pour maintenir une qualité Hi-Fi pour les sons reproduits par cet appareil.
- **Lors de la connexion d'un amplificateur extérieur à cet appareil**, diminuez le réglage du gain sur l'amplificateur extérieur pour obtenir les meilleures performances de cet appareil.

Het is mogelijk om uw autostereosysteem uit te breiden met een versterker of andere apparatuur.

- Verbind de externe kabel (blauw met witte streep) met de externe kabel van het andere apparaat zodat deze op afstand vanaf deze apparaat kan worden bediend.

Voor KD-SH77R:

- Alleen voor een versterker:
 - Verbind de uitgang van het apparaat met de ingang van de versterker.
 - **Koppel de speakers van dit apparaat los en verbind ze aan de versterker. Gebruik de speakerdraden van dit apparaat niet.**
 - Het is mogelijk de ingebouwde versterker uit te schakelen en de audiosignalen alleen naar de externe versterker(s) te sturen. U krijgt zo een helderder geluid en voorkomt dat zich warmte in de eenheid opbouwt. Zie bladzijde 25 van de instructies (aparte uitgave).
 - Het uitgangsniveau van het geluid is hoog om het hi-fi-geluid van deze eenheid te behouden.
- **Wanneer u een extern apparaat op deze eenheid aansluit**, moet u erop letten dat u de versterkingsfactor van de externe versterker laag houdt, zodat deze eenheid de beste prestaties levert.

For KD-SH55R:

- For amplifier:
 - Connect this unit's line-out terminals to the amplifier's line-in terminals.
 - **Disconnect the speakers from this unit, connect them to the amplifier. Leave the speaker leads of this unit unused.**
- For Subwoofer: A low-pass filter is required when using an amplifier of other manufactures than JVC. You can adjust the output level through the EXT OUT plugs (see page 20 of the Instruction (separate volume)).

Für KD-SH55R:

- Für den Verstärker:
 - Die Anschlußklemmen am Ausgang dieses Gerät an den Anschlußklemmen des Eingangs des Verstärkers anschließen.
 - **Die Lautsprecher von diesem Gerät abtrennen und am Verstärker anschließen. Die Lautsprecherleitungen dieses Geräts unbenutzt lassen.**
- Hinweise zum Subwoofer: Es ist ein Tiefpaßfilter erforderlich, wenn Sie keinen JVC-Verstärker verwenden. Sie können den Ausgangspegel einstellen, der über die Anschlüsse EXT OUT bereitgestellt wird (siehe Seite 20 der (separaten) Bedienungsanleitung).

Pour le KD-SH55R:

- Pour l'amplificateur seulement:
 - Raccorder les bornes de sortie ligne de cet appareil aux bornes d'entrée ligne de l'amplificateur.
 - **Déconnectez les enceintes de cet appareil et connectez-les à l'amplificateur. Laissez les fils d'enceintes de cet appareil inutilisés.**
- **Pour le caisson de grave: Si vous utilisez un amplificateur d'un autre fabricant que JVC, vous devez connecter un filtre passe-bas. Vous pouvez ajuster le niveau de sortie par les fiches de sortie auxiliaire (EXT OUT) (référez-vous à la page 20 du mode d'emploi (volume séparé)).**

Voor KD-SH55R:

- Alleen voor een versterker:
 - Verbind de uitgang van het apparaat met de ingang van de versterker.
 - **Koppel de speakers van dit apparaat los en verbind ze aan de versterker. Gebruik de speakerdraden van dit apparaat niet.**
- Voor de subwoofer: Als u een versterker van een ander merk dan JVC gebruikt, hebt u een low-pass filter nodig. Het uitvoervolume kan worden aangepast via de EXT OUT-stekkers (zie pagina 20 van de instructies - aparte uitgave).

Signal cord (not supplied with this unit)
Einzelleitung (nicht mit diesem Gerät mitgeliefert)
Cordon de signal (non fourni avec cet appareil)
Signaalkabel (wordt niet bij dit apparaat geleverd)

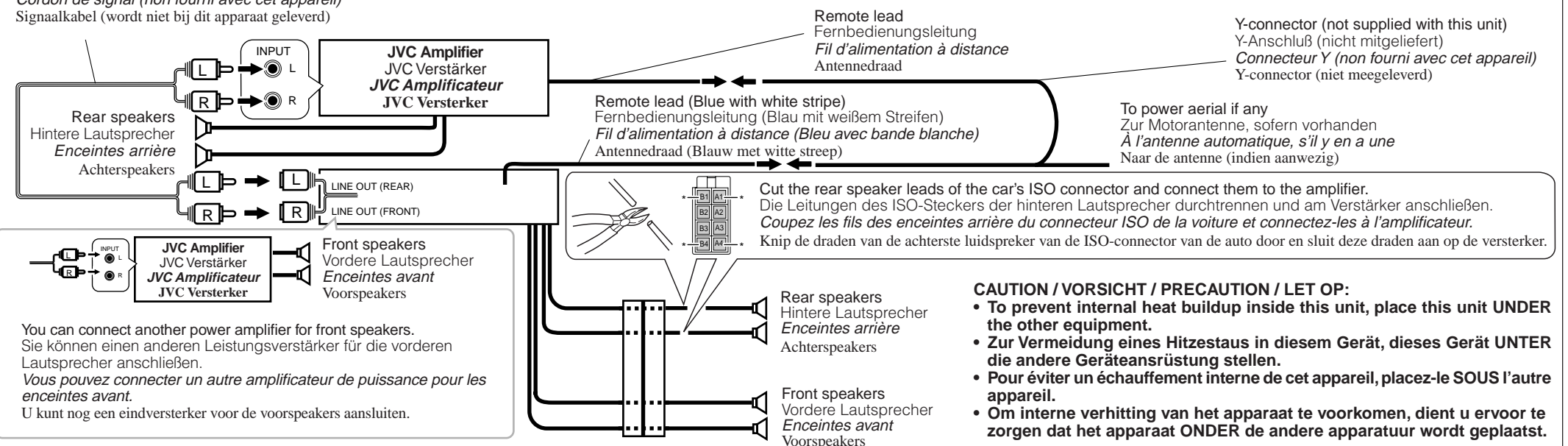

You can connect another power amplifier for front speakers.
Sie können einen anderen Leistungsverstärker für die vorderen Lautsprecher anschließen.
Vous pouvez connecter un autre amplificateur de puissance pour les enceintes avant.
U kunt nog een eindversterker voor de voorspeakers aansluiten.

CD changer and DAB tuner / CD-Wechsler und DAB-Tuner / Changeur CD et tuner DAB / CD-wisselaar en DAB-tuner

You can connect a JVC CD changer and/or a JVC DAB (Digital Audio Broadcasting) tuner.

- For their connections, refer to the instructions supplied for them.

Sie können einen CD-Wechsler und/oder einen DAB-Tuner (Tuner für digitalen Rundfunk) von JVC anschließen.

- Weitere Informationen über den Anschluß können Sie der Bedienungsanleitung entnehmen, die dem jeweiligen Gerät beiliegt.

Vous pouvez connecter un changeur CD JVC et/ou un tuner DAB (Digital Audio Broadcast) JVC.

- Pour leurs connexions, référez-vous aux modes d'emploi qui les accompagnent.

Het is mogelijk een JVC CD-wisselaar en/of JVC DAB-tuner (Digital Audio Broadcasting) aan te sluiten.

- Zie de instructies van deze apparaten voor meer informatie over het tot stand brengen van deze aansluiting.

Connecting cord supplied with your DAB tuner
Verbindingskabel, das zum Lieferumfang des DAB-Tuners gehört
Cordon de connexion fourni avec votre tuner DAB
Verbindingskabel die met de DAB-tuner wordt meegeleverd

Connecting cord supplied with your CD changer
Verbindingskabel, das zum Lieferumfang des CD-Wechsler gehört
Cordon de connexion fourni avec votre changeur CD
Verbindingskabel die met de CD-wisselaar wordt meegeleverd

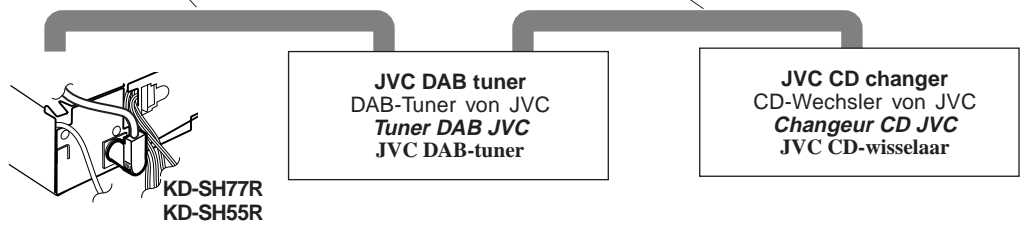

- You can connect both components in series as illustrated above.
- Es ist möglich, beide Komponenten in einer Serienschaltung entsprechend der obigen Darstellung anzuschließen.
- Vous pouvez connecter les deux appareils en série comme montré ci-dessus.
- Beide apparaten zijn volgens bovenstaande illustratie in serie aan te sluiten.

Connecting cord supplied with your DAB tuner or CD changer
Verbindingskabel, das zum Lieferumfang des DAB-Tuners oder CD-Wechslers gehört
Cordon de connexion fourni avec votre tuner DAB ou changeur CD
Verbindingskabel die met de DAB-tuner of CD-wisselaar wordt meegeleverd

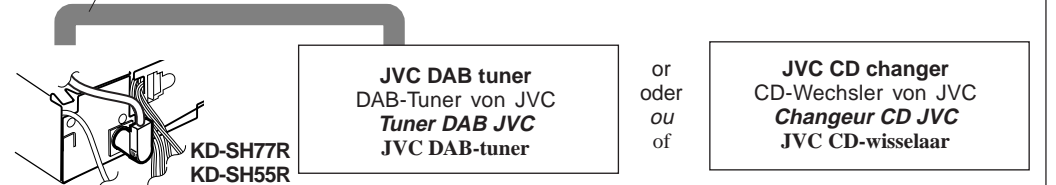

CAUTION / VORSICHT / PRECAUTION / LET OPI!

- Before connecting the CD changer and/or the DAB tuner, make sure that the unit is turned off.
- Bevor Sie den CD-Wechsler und/oder den DAB-Tuner anschließen, vergewissern Sie sich, daß das Gerät ausgeschaltet ist.
- Avant de connecter le changeur CD et/ou le tuner DAB, s'assurer que l'unité est éteinte.
- Zorg ervoor dat de apparat is uitgeschakeld alvorens u de en/of DAB-tuner CD-wisselaar aansluit.

Subwoofer and other source equipment / Subwoofer und andere externe Geräte / Caisson de grave et autre appareil source / Subwoofer en andere apparatuur

You can connect a subwoofer to reinforce the bass.

- For their connections, refer to the instructions supplied with your subwoofer.

Sie können einen Subwoofer zur Baßverstärkung anschließen.

- Informationen darüber, wie diese Geräte angeschlossen werden, finden Sie in der Bedienungsanleitung, die zum Lieferumfang der jeweiligen Komponente gehört.

Vous pouvez connecter un caisson de grave pour renforcer les graves.

- Pour leur connexion, référez-vous aux instructions fournies avec chaque appareil.

Het is mogelijk om een subwoofer aan te sluiten om het basgeluid te versterken.

- Raadpleeg de instructies die bij het desbetreffende apparaat werden meegeleverd voor meer informatie over het totstandbrengen van deze aansluitingen.

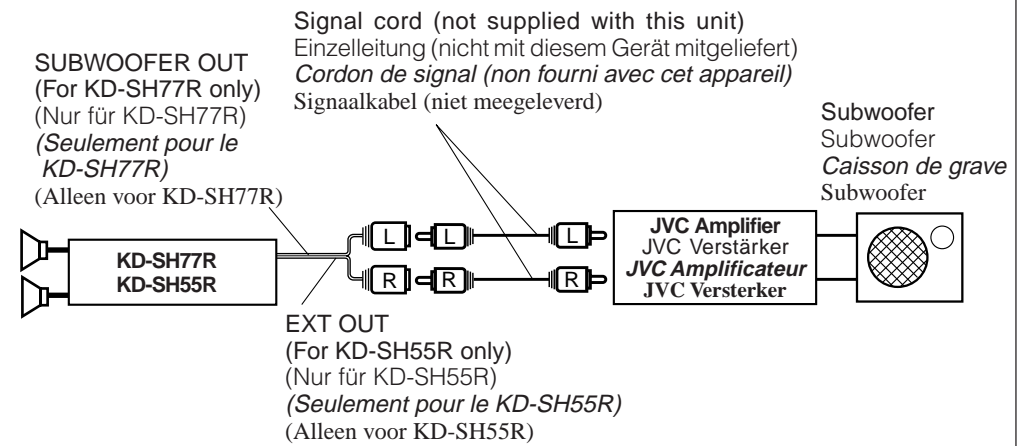

DVD, VCR or TV / DVD, Videorecorder oder Fernsehgerät / DVD, Magnéscope ou Téléviseur / DVD, Videorecorders en TV

For KD-SH77R only / Nur für KD-SH77R / Seulement pour le KD-SH77R / Alleen voor KD-SH77R

Signal cord (not supplied with this unit)
Einzelleitung (nicht mit diesem Gerät mitgeliefert)
Cordon de signal (non fourni avec cet appareil)
Signaalkabel (niet meegeleverd)

Signal cord (not supplied with this unit)
Einzelleitung (nicht mit diesem Gerät mitgeliefert)
Cordon de signal (non fourni avec cet appareil)
Signaalkabel (niet meegeleverd)

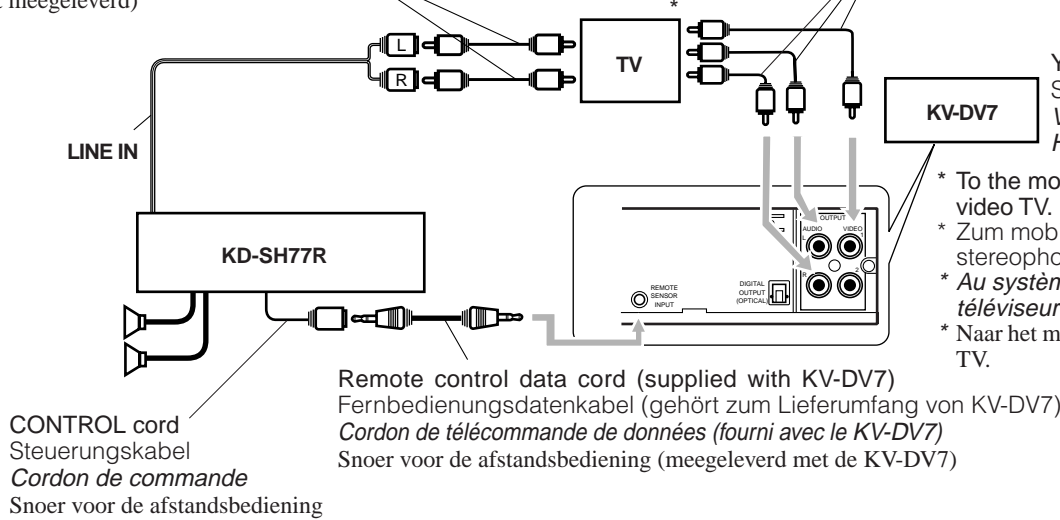

You can connect the DVD player (KV-DV7).
Sie können den DVD-Spieler (KV-DV7) anschließen.
Vous pouvez connecter un lecteur de DVD (KV-DV7).
Het is mogelijk een DVD (KV-DV7) aan te sluiten.

- To the mobile color monitor system or the audio-video input terminal of a stereo audio-video TV.
- Zum mobilen Farb- oder Monitorsystem oder dem Audio-Video-Eingang eines stereophonen Audio-Video-Fernsehgeräts.
- Au système mobile de moniteur couleur ou aux prises d'entrée audio-vidéo d'un téléviseur stéréo audio-vidéo.
- Naar het mobiele kleuren of monitorsysteem of de audio-/video-ingang van een stereo audio/video TV.

External component / Externe Komponente / Appareil extérieur / Extern apparaat

For KD-SH55R only / Nur für KD-SH55R / Seulement pour le KD-SH55R / Alleen voor KD-SH55R

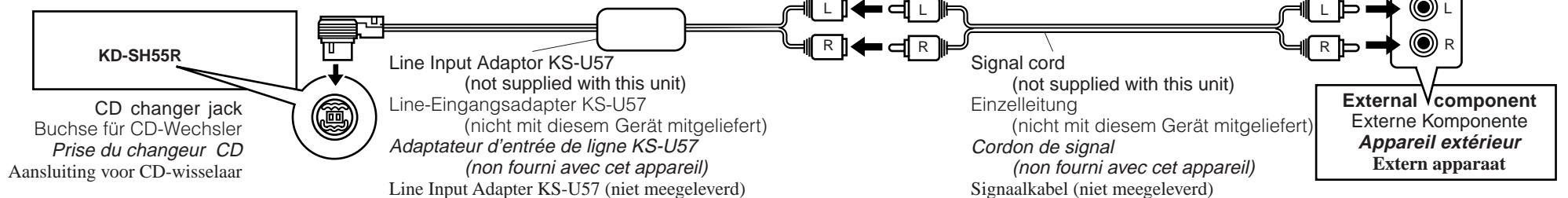

TROUBLESHOOTING

FEHLERSUCHE

EN CAS DE DIFFICULTES

PROBLEMEN OPLOSSEN

- The fuse blows.**
* Are the red and black leads connected correctly?
- Power cannot be turned on.**
* Is the yellow lead connected?
- No sound from the speakers.**
* Is the speaker output lead short-circuited?
- Sound is distorted.**
* Is the speaker output lead grounded?
* Are the "-" terminals of L and R speakers grounded in common?
- Unit becomes hot.**
* Is the speaker output lead grounded?
* Are the "-" terminals of L and R speakers grounded in common?

- Die Sicherung brennt durch.**
* Sind die roten und schwarzen Leitungen richtig angeschlossen?
- Stromversorgung kann nicht eingeschaltet werden.**
* Ist die gelbe Leitung angeschlossen?
- Kein Ton aus den Lautsprechern.**
* Ist die LautsprecherAusgangsleitung kurzgeschlossen?
- Ton verzerrt.**
* Ist die LautsprecherAusgangsleitung geerdet?
* Sind die (-) Anschlußklemmen der linken und rechten Lautsprecher zusammen geerdet?
- Gerät wird heiß.**
* Ist die LautsprecherAusgangsleitung geerdet?
* Sind die (-) Anschlußklemmen der linken und rechten Lautsprecher zusammen geerdet?

- Le fusible saute.**
* Les fils rouge et noir sont-ils raccordés correctement?
- L'appareil ne peut pas être mise sous tension.**
* Le fil jaune est-elle raccordée?
- Pas de son des enceintes.**
* Le fil de sortie d'enceinte est-il court-circuité?
- Le son est déformé.**
* Le fil de sortie d'enceinte est-il à la masse?
* Les bornes "-" des enceintes gauche et droit sont-elles mises ensemble à la masse?
- L'appareil devient chaud.**
* Le fil de sortie d'enceinte est-il à la masse?
* Les bornes "-" des enceintes gauche et droit sont-elles mises ensemble à la masse?

- De zekering slaat door.**
* Zijn de rode en de zwarte draden op de juiste manier aangesloten?
- De stroom kan niet worden ingeschakeld.**
* Is de gele draad aangesloten?
- Er komt geen geluid uit de speakers.**
* Is de uitgaande speakerdraad kortgesloten?
- Het geluid wordt vervormd.**
* Is de uitgaande speakerdraad geaard?
* Zijn de minpolen van de linker- en de rechterspeakers gemeenschappelijk geaard?
- Het apparaat raakt verhit.**
* Is de uitgaande speakerdraad geaard?
* Zijn de minpolen van de linker- en de rechterspeakers gemeenschappelijk geaard?